

Pressure regulator G1/8" Series Modul RE03

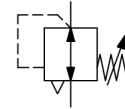

Design type	Diaphragm pressure regulator with secondary venting
Connection	G1/8" according to ISO228/1
Materials	Housing Zinc die casting, Seals NBR, Spring cap POM
Function	Secondary pressure regulation
Locking mechanism	Pressure setting can be locked by pressing in the rotary knob
Mounting type	Installation in piping system or Wall mounting using mounting bracket
Mounting position	any
Medium	filtered compressed air
Medium temperature	0...+60°C, (with appropriately conditioned compressed air -10...+60°C)
Ambient temperature	-10...+60°C
Inlet pressure	maximum 16bar
Control ranges	0,1...3/0,2...6/0,5...10 and 0,5-16bar
Flow direction	is marked by an arrow
Scope of delivery	including pressure gauge



Dimensional drawing

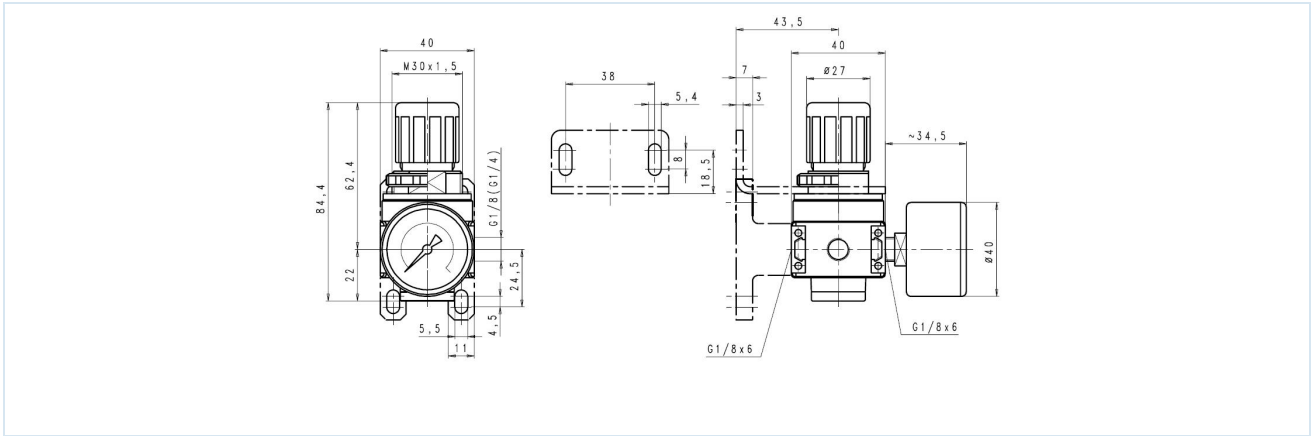

Connection	Flow rate at 6 bar* [Nl/min]	Pressure range [bar]	Type
G1/8"	1100	0,1...3	RE03-18H-0,1/3-MA
G1/8"	1100	0,2...6	RE03-18H-0,2/6-MA
G1/8"	1100	0,5...10	RE03-18H-0,5/10-MA
G1/8"	1100	0,5...16	RE03-18H-0,5/16-MA

*Flow rate data at an inlet pressure of 8 bar, an outlet pressure of 6 bar and a pressure drop of 1 bar

Flow diagram for control range 0,5...10bar

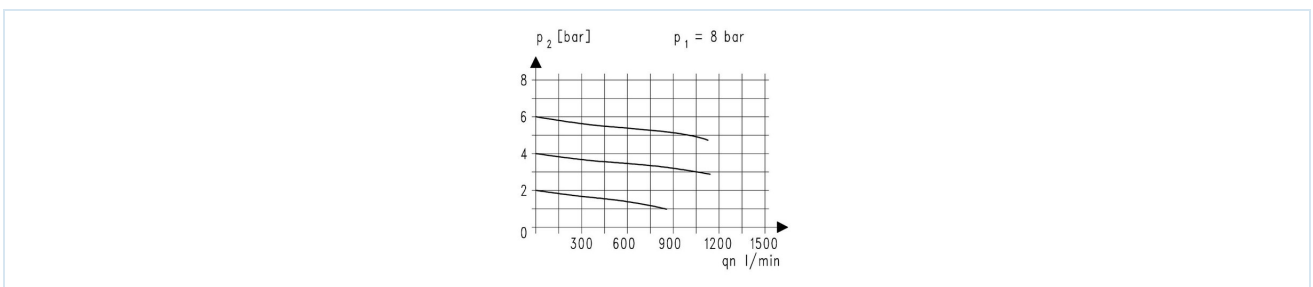

Accessories

Designation	Type
Mounting bracket kit	MMB03-18-14
Locknut M30x1,5	MPN03-18-38
Holding angle bracket with neck nut	MMP03-18-38

Illustrations non-binding
Design, dimensional and material changes reserved

Pneumatics / Regulators, filters and lubricators / Maintenance devices - series Modul / Pressure regulator Series Modul RE03 / [RE03-18H-0,1/3-MA] Pressure regulator RE03-18H-0,1/3-MA

Version 5

138915 / Generated 2026/23 EN

MADE IN EUROPE

+43 512 52076
austria@stasto.eu
© STASTO Automation KG

www.stasto.com

Open series online

Page 2 / 2

