

## Pressure regulator G11/4"...G11/2" Series Gold RE04

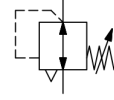

Design type	Diaphragm pressure regulator with secondary venting
Connection	G11/4"...G11/2" according to ISO228/1
Materials	Housing and spring bonnet Aluminium, Seals NBR
Function	Secondary pressure regulation
Mounting position	any
Medium	filtered compressed air
Medium temperature	0...+60°C, (with appropriately conditioned compressed air -10...+60°C)
Ambient temperature	-10...+80°C
Inlet pressure	max. 25bar
Control ranges	0,1...3/ 0,2...6/ 0,5...10 and 0,5...16bar
Flow direction	is marked by an arrow
Scope of delivery	including pressure gauge



## Dimensional drawing

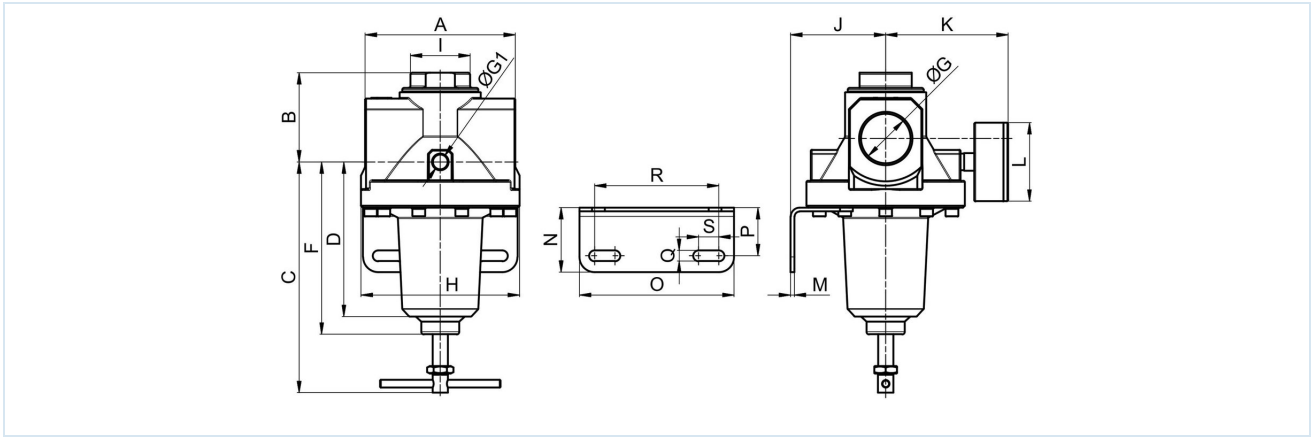

Connection G	A	B	C	D	F	G1	H	I	J	K	L	M	N	O	P	Q	R	S
G11/4"	119	71	201	122	136	1/4"	125	47	75	97	63	3	51	122	38	8,5	98	16
G11/2"	119	71	201	122	136	1/4"	125	47	75	97	63	3	51	122	38	8,5	98	16

Connection	Flow rate at 6 bar* [Nl/min]	Inlet pressure [bar]	Pressure range [bar]	Weight [approx. kg]	Type
G11/4"	16500	25	0,1...3	2,9	RE04-114-0,1/3-MA
G11/4"	16500	25	0,5...10	2,9	RE04-114-0,5/10-MA
G11/4"	16500	25	0,5...16	2,9	RE04-114-0,5/16-MA
G11/2"	16500	25	0,1...3	2,8	RE04-112-0,1/3-MA
G11/2"	16500	25	0,5...10	2,8	RE04-112-0,5/10-MA
G11/2"	16500	25	0,5...16	2,8	RE04-112-0,5/16-MA

\*Flow rate data at an inlet pressure of 8 bar, an outlet pressure of 6 bar and a pressure drop of 1 bar

## Flow diagram for control range 0,5...10bar

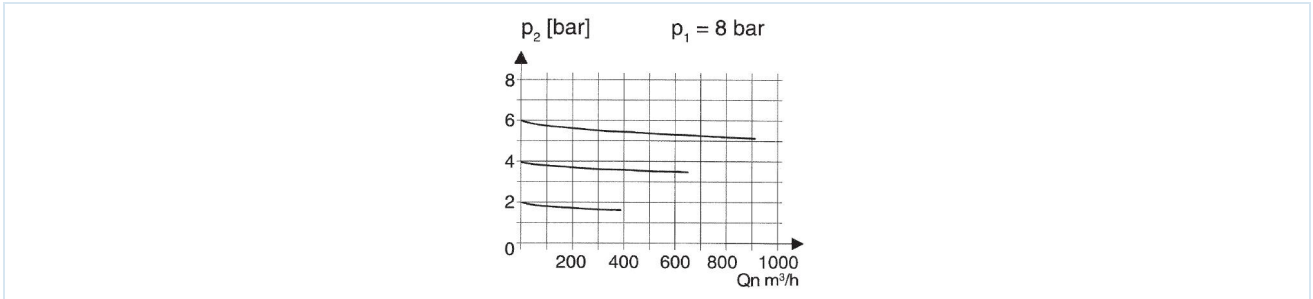

## Accessories

Designation	Type
Holding angle	MMB04-34/112

Illustrations non-binding

Design, dimensional and material changes reserved

Pneumatics / Regulators, filters and lubricators / Maintenance devices - series Gold / Pressure regulator Series Gold RE04 / [RE04-112-0,1/3-MA] Pressure regulator RE04-112-0,1/3-MA

Version 5

139039 / Generated 2026/23 EN

MADE IN EUROPE

+43 512 52076

austria@stasto.eu

© STASTO Automation KG

www.stasto.com

Open series online

Page 2 / 2

