

## Pressure and vacuum switch Series 901



Design type	Diaphragm pressure switch with changeover contact
Connection	G1/4" Male thread
Materials	Body Brass, Upper part PVDF, Diaphragm NBR
Switching point adjustment	Switching point adjustment via the handwheel with scale
Accuracy of the reference scale	+/- 10%
Medium temperature	0...+85°C
Ambient temperature	-20...+85°C
Switching capacity AC with resistive load	max. 6A/250VAC
DC switching capacity with resistive load	max. 2A/24VDC
Degree of protection	Protective cap IP44, Protective cap with PG cable gland IP54, Protective cap with device socket IP65
Application range	Compressed air, Water, neutral gases, neutral oils
Switching cycles	1 million switching cycles
Mounting	via threaded connection or mounting bracket
Scope of delivery	without protective cap
Accessories	Mounting brackets and protective caps IP44, IP54 and IP65
Special version	Switching contact gold-plated, other diaphragm materials, Damping nozzles for reducing pressure surges, higher overpressure safety



## Pressure switch

Adjustment range [mbar]	Overpressure safety [bar]	approx. Reset differential [mbar] non-adjustable	Weight [kg]	Type
5...20	0,5	3	0,13	901.61
10...50	0,5	5	0,13	901.62
25...100	0,5	10	0,13	901.63
50...250	1	20	0,13	901.64
100...500	1	50	0,13	901.65
250...1000	10	150	0,13	901.66
500...1500	10	250	0,13	901.67
1000...3000	10	500	0,13	901.68

Adjustment range [bar]	Overpressure safety [bar]	Reset differential [bar] non-adjustable	Weight [kg]	Type
1-6	25	0,5-2	0,19	901.91
4-9	25	0,5-2	0,19	901.92

## Vacuum switch

Adjustment range [mbar]	Overpressure safety [bar]	approx. Reset differential [mbar] non-adjustable	Weight [kg]	Type
-5...-20	0,5	3	0,13	901.71
-10...-50	0,5	5	0,13	901.72
-25...-100	0,5	10	0,13	901.73
-50...-125	0,5	20	0,13	901.74
-75...-200	1	25	0,13	901.75
-100...-300	1	30	0,13	901.76
-200...-500	1	75	0,13	901.77
-300...-700	1	75	0,13	901.78

## Dimensions

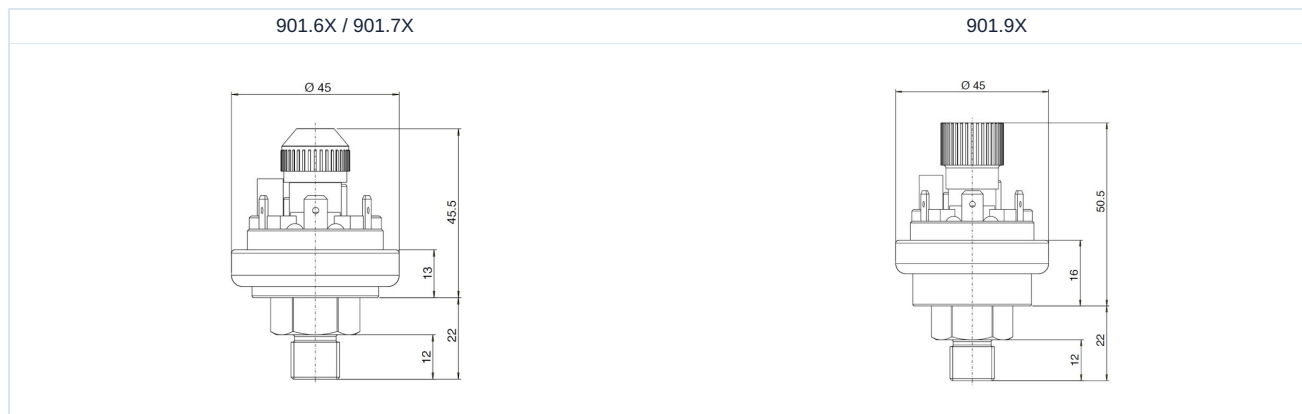

## Accessories

Protective cap IP44  
Type PC-PVS01-01

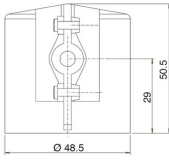

Protective cap with PG cable gland  
Type 6371 (IP54) / 6372 (IP65)

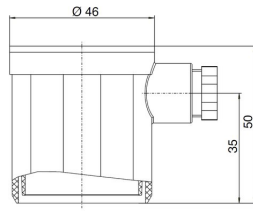

Protective cap with device socket IP65  
Type 6379

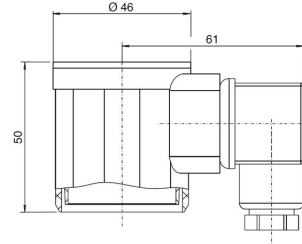

Mounting bracket Type 6403

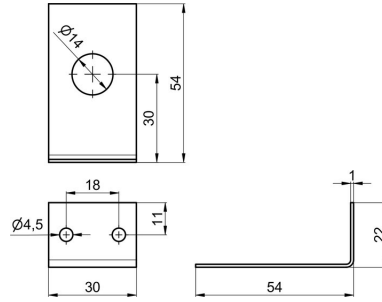

## Electrical connection

Pressure switch

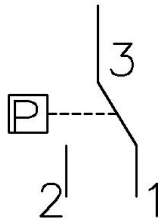

Vacuum switch

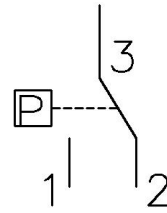

Illustrations non-binding

Design, dimensional and material changes reserved

Armatures / Pressure switches, measuring instruments and flow monitors / Pressure switch / Pressure switch Series 901.6

