

## Vijačni priključki - Medenina, ponikljana Serija SC

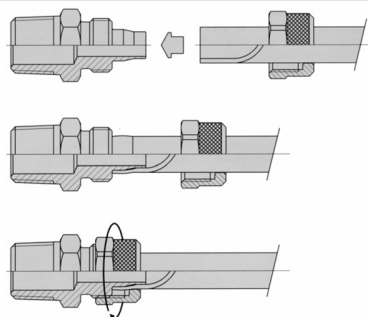

Konstrukcija	Vijačni priključek z navojno matico
Priključek	1/8" ... 1/2" izbirno cilindrični po ISO 228/1 ali konični po ISO 7/1, M5 po ISO R/262
Zunanji premer cevi	4...15 mm
Materiali	Medenina, ponikljana
priporočeno Materiali cevi	Poliamid (PA), Poliuretan (PU/CP), polietilen (PE), PTFE (PT)
Tolerance cevi	+/- 0,05mm do premera 10mm, +/- 0,1mm od premera 12mm
Medij	Stisnjen zrak, nevtralni plini
Temperatura medija	-20...+70°C (-40...+150°C na zahtevo)
Obratovalni tlak	-1...18bar oziroma -1...25bar, odvisno od maksimalnega tlaka uporabljene cevi

### Navodila za montažo



1. Cev odrežite pravokotno
2. Prekrivno matico natakните na cevko
3. Cev in prekrivno matico potisnite čez stožec cevi do končnega naslona
4. Preklopno matico privijte ročno ali po potrebi s ključem do konca

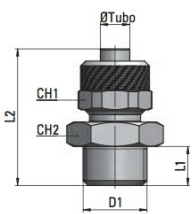

### SC12 Ravni vijačni priključek - Cilindrični navoj, Tlak -1...18bar

	Premer cevi D / d [mm]	D1	L1	L2	CH1	CH2	Teža [g]	Tip
	4/2,5	M5x0,8	5	20	7	7	3,5	SC12-04-M5-N-D
	4/2,5	G1/8"	6	22,5	7	14	10	SC12-04-18-N-D
	5/3	M5x0,8	4	20	8	8	5	SC12-05-M5-N-0
	5/3	G1/8"	6	23	8	14	14,5	SC12-05-18-N-0
	6/4	M5x0,8	4	21	9	8	6	SC12-06-M5-N-0
	6/4	M12x1,25	8	28	12	17	21	SC12-06-12X1,25-N-D
	6/4	M12x1,5	8	28	12	17	21	SC12-06-12X1,5-N-D
	6/4	G1/8"	5,5	23,5	10	14	16	SC12-06-18-N-0
	6/4	G1/4"	6,5	25,5	10	16	24	SC12-06-14-N-0
	6/4	G3/8"	9	28	10	19	28	SC12-06-38-N-0
	6/4	G1/2"	10	30	10	24	37	SC12-06-12-N-0
	8/6	G1/8"	5,5	23	12	14	19	SC12-08-18-N-0
	8/6	G1/4"	6,5	25,5	12	16	25	SC12-08-14-N-0
	8/6	G3/8"	9	28	12	19	30	SC12-08-38-N-0
	8/6	G1/2"	10	30	12	24	40	SC12-08-12-N-0
	10/8	G1/8"	5,5	26,5	14	14	23	SC12-10-18-N-0
	10/8	G1/4"	6,5	28,5	14	16	29	SC12-10-14-N-0
	10/8	G3/8"	9	30	14	19	32	SC12-10-38-N-0
	10/8	G1/2"	10	32	14	24	45	SC12-10-12-N-0
	12/10	G3/8"	9	30,5	15	19	39	SC12-12-38-N-0
12/10	G1/2"	10	32,5	15	24	53	SC12-12-12-N-0	
15/12,5	G1/2"	10	34,5	22	24	58	SC12-15-12-N-0	

### SC12C Ravni vijačni priključek - Stožčasti navoj, Tlak -1...25bar

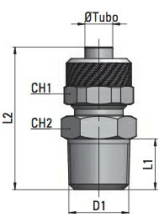
	Premer cevi D / d [mm]	D1	L1	L2	CH1	CH2	Teža [g]	Tip
	4/2,5	R1/8"	7,5	23,5	7	11	7	SC12C-04-18-N
	5/3	R1/8"	8	25	8	12	9	SC12C-05-18-N
	6/4	R1/8"	8	27,5	12	12	18	SC12C-06-18-N
	6/4	R1/4"	11	31	12	14	21	SC12C-06-14-N
	6/4	R3/8"	11,5	31,5	12	17	25	SC12C-06-38-N
	8/6	R1/8"	8	27,5	14	12	18	SC12C-08-18-N
	8/6	R1/4"	11	31	14	14	23	SC12C-08-14-N
	8/6	R3/8"	11,5	31,5	14	17	29	SC12C-08-38-N
	10/8	R1/8"	8	29,5	16	14	22	SC12C-10-18-N
	10/8	R1/4"	11	32,5	16	14	27	SC12C-10-14-N
	10/8	R3/8"	11,5	33	16	17	34	SC12C-10-38-N
	10/8	R1/2"	14	36	16	22	48	SC12C-10-12-N
	12/10	R3/8"	11,5	34,5	18	17	37	SC12C-12-38-N
	12/10	R1/2"	14	37,5	18	22	50	SC12C-12-12-N
	15/12,5	R1/2"	14	39,5	22	22	62	SC12C-15-12-N

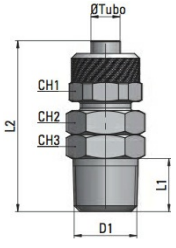

### SC12C Vrtljiv, ravni vijačni priključek - Stožčasti navoj, Tlak -1...18bar

	Premer cevi D / d [mm]	D1	L1	L2	CH1	CH2	CH3	Teža [g]	Tip
	6/4	R1/8"	8	37	12	12	12	22	SC12C-06-18-N-360YA
6/4	R1/4"	11	40	12	14	14	28	SC12C-06-14-N-360YA	
8/6	R1/8"	8	37	14	12	12	26	SC12C-08-18-N-360YA	
8/6	R1/4"	11	40	14	14	14	30	SC12C-08-14-N-360YA	
10/8	R1/4"	11	42	16	14	14	34	SC12C-10-14-N-360	
10/8	R3/8"	11,5	39	16	14	17	43	SC12C-10-38-N-360	

### SC13 Ravni vijačni priključek, Tlak -1...25bar

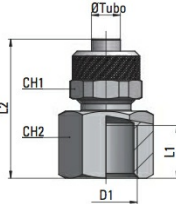
	Premer cevi D / d [mm]	D1	L1	L2	CH1	CH2	Teža [g]	Tip
	5/3	G1/8"	8	22,5	8	14	13	SC13-05-18-N
6/4	G1/4"	11	29	12	17	26	SC13-06-14-N	
8/6	G1/8"	8	25	14	14	22	SC13-08-18-N	
8/6	G1/4"	11	29	14	17	29	SC13-08-14-N	
8/6	G3/8"	11,5	29,5	14	20	31	SC13-08-38-N	
8/6	G1/2"	15	33	12	24	61	SC13-08-12-N	
10/8	G1/4"	11	30,5	16	17	32	SC13-10-14-N	
10/8	G3/8"	11,5	31	16	20	38	SC13-10-38-N	
12/10	G3/8"	11,5	32,5	18	20	54	SC13-12-38-N	

### SC13 Ravni spojnik, Tlak -1...25bar

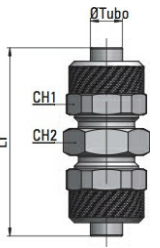
	Premer cevi D1 [mm]	Premer cevi D2 [mm]	L1	CH1	CH2	Teža [g]	Tip
	5/3	5/3	28,5	8	8	8	SC13-05-N
6/4	6/4	34,5	12	12	21	SC13-06-N	
8/6	8/6	35	14	14	25	SC13-08-N	
10/8	10/8	38	16	14	38	SC13-10-N	
12/10	12/10	41	18	17	47	SC13-12-N	
15/12,5	15/12,5	45,5	22	22	83	SC13-15-N	

### SC14 Vrtljiva kotna vijačna priključna spojka, Tlak -1...18bar

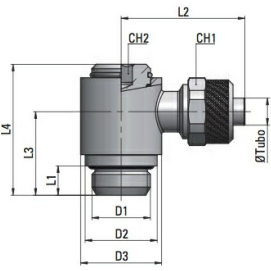
	Premer cevi D / d [mm]	D1	D2	D3	L1	L2	L3	L4	CH1	CH2	Teža [g]	Tip
	6/4	G1/8"	14	14	5	25	16,5	25,5	12	4	27	SC14-06-18-N-0-360
6/4	G1/4"	16	18	6,5	26,5	19	29	12	5	42	SC14-06-14-N-0-360	
8/6	G1/8"	14	14	5	25	16,5	25,5	14	4	29	SC14-08-18-N-0-360	
8/6	G1/4"	16	18	6,5	27,5	19	29	14	5	44	SC14-08-14-N-0-360	
10/8	G1/4"	16	18	6,5	28,5	19	29	16	5	46	SC14-10-14-N-0-360	
10/8	G3/8"	21	18	7	30,5	23,5	32,5	16	8	69	SC14-10-38-N-0-360	



### SC14 L-vrtljiva vijačna spojka, Tlak -1...18bar

Premer cevi D / d [mm]	D1	L1	L2	L3	L4	CH1	CH2	Teža [g]	Tip
4/2,5	M5x0,8	4	19	9,5	19	7	8	9	SC14-04-M5-N
4/2,5	G1/8"	6	21,5	16,5	27	7	14	28	SC14-04-18-N
5/3	M5x0,8	4	19	9,5	19	8	8	11	SC14-05-M5-N
5/3	G1/8"	6	25	16,5	27	8	14	27	SC14-05-18-N
6/4	M5x0,8	4	19	9,5	19	9	8	11	SC14-06-M5-N
6/4	G1/8"	6	25	16,5	27	12	14	32	SC14-06-18-N
6/4	G1/4"	8	26,5	19,5	31,5	12	17	52	SC14-06-14-N
8/6	G1/8"	6	25	16,5	27	14	14	34	SC14-08-18-N
8/6	G1/4"	8	27,5	19,5	31,5	14	17	55	SC14-08-14-N
8/6	G3/8"	9	29,5	23,5	36	14	20	82	SC14-08-38-N
10/8	G1/4"	8	28,5	19,5	31,5	16	17	57	SC14-10-14-N
10/8	G3/8"	9	30,5	23,5	36	16	20	85	SC14-10-38-N

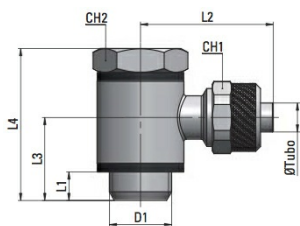

### SC16 Vrtljiva kotna vijačna priključna spojka - Cilindrični navoj, Tlak -1...18bar

Premer cevi D / d [mm]	D1	L1	L2	L3	CH1	CH2	CH3	Teža [g]	Tip
6/4	G1/8"	6	16	22,5	12	8	14	23	SC16-06-18-N-0-360
6/4	G1/4"	8	17	23	12	10	17	35	SC16-06-14-N-0-360
8/6	G1/8"	6	15	23	14	10	14	29	SC16-08-18-N-0-360
8/6	G1/4"	8	17	23	14	10	17	36	SC16-08-14-N-0-360
10/8	G1/4"	8	18	25	16	11	17	43	SC16-10-14-N-0-360

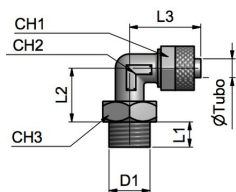

### SC16C Kotna vijačna priključna spojka - Stožčasti navoj, Tlak -1...25bar

Premer cevi D / d [mm]	D1	L1	L2	L3	CH1	CH2	Teža [g]	Tip
4/2,5	M5x0,8	5	15,5	20	7	9	10	SC16C-04-M5-N
4/2,5	R1/8"	7,5	17	20	7	9	11	SC16C-04-18-N
5/3	R1/8"	8	17	21,5	8	8	11	SC16C-05-18-N
6/4	M12x1,25	9	21	22,5	12	10	23	SC16C-06-M12X1,25-N
6/4	M12x1,5	9	21	22,5	12	10	19	SC16C-06-M12X1,5-N
6/4	R1/8"	8	17	22,5	12	8	16	SC16C-06-18-N
6/4	R1/4"	11	20	22,5	12	10	22	SC16C-06-14-N
6/4	R3/8"	11,5	22,5	23,5	12	11	30	SC16C-06-38-N
8/6	R1/8"	8	17	22,5	14	10	20	SC16C-08-18-N
8/6	R1/4"	11	20	22,5	14	10	23	SC16C-08-14-N
8/6	R3/8"	11,5	22,5	24	14	11	31	SC16C-08-38-N
10/8	R1/8"	8	18,5	25,5	16	11	28	SC16C-10-18-N
10/8	R1/4"	11	21,5	25,5	16	11	31	SC16C-10-14-N
10/8	R3/8"	11,5	22,5	25,5	16	11	36	SC16C-10-38-N
10/8	R1/2"	14	28	25,5	16	17	40	SC16C-10-12-N
12/10	R3/8"	11,5	24,5	30	18	14	46	SC16C-12-38-N
12/10	R1/2"	14	28	30,5	18	17	60	SC16C-12-12-N
15/12,5	R1/2"	14	28	34	22	17	69	SC16C-15-12-N

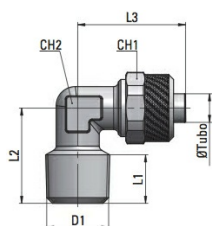

### SC17 Kotni priključek, Tlak -1...25bar

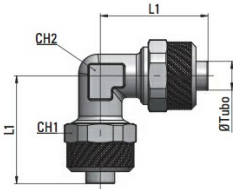
	Premer cevi D / d [mm]	L1	L2	CH1	CH2	Teža [g]	Tip
	5/3	21,5	21,5	8	8	13	SC17-05-N
6/4	21,5	21,5	12	8	23	SC17-06-N	
8/6	22,5	22,5	14	10	28	SC17-08-N	
10/8	25,5	25,5	16	11	38	SC17-10-N	
12/10	30	30	18	14	60	SC17-12-N	
15/12,5	34	34	22	17	84	SC17-15-N	

### SC17 Kotna navojna vijačna spojka, Tlak -1...25bar

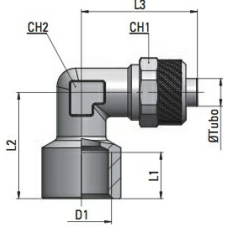
	Premer cevi D / d [mm]	D1	L1	L2	L3	CH1	CH2	Teža [g]	Tip
	5/3	G1/8"	8	19	21,5	8	10	21	SC17-05-18-N
6/4	G1/8"	8	19	22,5	12	10	21	SC17-06-18-N	
6/4	G1/4"	10,5	23	25	12	11	30	SC17-06-14-N	
8/6	G1/8"	8	19	22,5	14	10	28	SC17-08-18-N	
8/6	G1/4"	10,5	23	25	14	11	31	SC17-08-14-N	
10/8	G1/4"	11	23,5	26	16	13	33	SC17-10-14-N	
12/10	G3/8"	11,5	28	30,5	18	17	70	SC17-12-38-N	

### SC20 Križni spojnik, Tlak -1...25bar

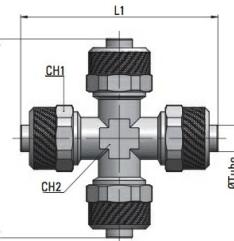
	Premer cevi D / d [mm]	L1	L2	CH1	CH2	Teža [g]	Tip
	5/3	43	43	8	8	45	SC20-05-N
6/4	45	45	12	8	45	SC20-06-N	
8/6	45	45	14	10	52	SC20-08-N	
10/8	51	51	16	11	72	SC20-10-N	

### SC21C T-navojni priključek - Stožčasti navoj, Tlak -1...25bar

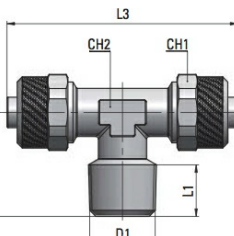
	Premer cevi D / d [mm]	D1	L1	L2	L3	CH1	CH2	Teža [g]	Tip
	5/3	R1/8"	8	17	43	8	8	18	SC21C-05-18-N
6/4	R1/8"	8	17	45	12	8	26	SC21C-06-18-N	
6/4	R1/4"	11	20,5	45,5	12	10	35	SC21C-06-14-N	
8/6	R1/8"	8	17,5	45,5	14	10	34	SC21C-08-18-N	
8/6	R1/4"	11	20,5	45,5	14	10	41	SC21C-08-14-N	
10/8	R1/4"	11	21,5	51	16	11	47	SC21C-10-14-N	
10/8	R3/8"	11,5	22,5	51	16	11	51	SC21C-10-38-N	
12/10	R3/8"	11,5	24,5	60	18	14	75	SC21C-12-38-N	
12/10	R1/2"	14	28	61	18	17	100	SC21C-12-12-N	
15/12,5	R1/2"	14	28	68	22	17	102	SC21C-15-12-N	

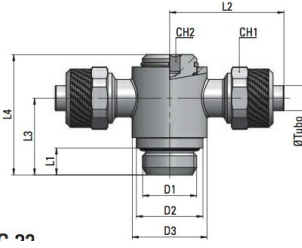

### SC22 Vrtljiva T-vijačna priključna spojka, Tlak -1...18bar

	Premer cevi D / d [mm]	D1	D2	D3	L1	L2	L3	L4	CH1	CH2	Teža [g]	Tip
	6/4	G1/8"	14	14	5	25	16,5	25,5	12	4	39	SC22-06-18-N-0-360
6/4	G1/4"	16	18	6,5	26,5	19	29	12	5	53	SC22-06-14N-0-360	
8/6	G1/8"	14	14	5	25	16,5	25,5	14	4	41	SC22-08-18N-0-360	
8/6	G1/4"	16	18	6,5	27,5	19	29	14	5	57	SC22-08-14N-0-360	
10/8	G1/4"	16	18	6,5	28,5	19	29	16	5	64	SC22-10-14N-0-360	
10/8	G3/8"	21	22	7	30,5	23,5	32,5	16	8	85	SC22-10-38N-0-360	

### SC22 T-vrtljiva vijačna spojka, Tlak -1...18bar

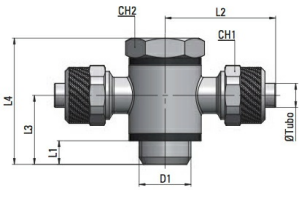
	Premer cevi D / d [mm]	D1	L1	L2	L3	L4	CH1	CH2	Teža [g]	Tip
	5/3	M5x0,8	4	17	9,5	19	8	8	15	SC22-05-M5-N
5/3	G1/8"	6	25	16,5	27	8	14	45	SC22-05-18-N	
6/4	M5x0,8	4	17	9,5	19	9	8	16	SC22-06-M5-N	
6/4	G1/8"	6	25	16,5	27	12	14	45	SC22-06-18-N	
6/4	G1/4"	8	26,5	19,5	31,5	12	17	63	SC22-06-14-N	
8/6	G1/8"	6	25	16,5	27	14	14	46	SC22-08-18-N	
8/6	G1/4"	8	27,5	19,5	31,5	14	17	67	SC22-08-14-N	
8/6	G3/8"	9	29,5	23,5	36	14	20	96	SC22-08-38-N	
10/8	G1/4"	8	28,5	19,5	31,5	16	17	72	SC22-10-14-N	
10/8	G3/8"	9	30,5	23,5	36	16	20	103	SC22-10-38-N	

### SC24C T-navojni priključek - Stožčasti navoj, Tlak -1...25bar

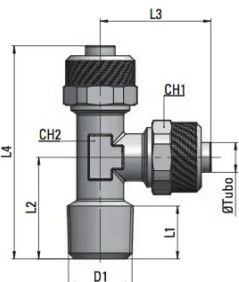
	Premer cevi D / d [mm]	D1	L1	L2	L3	L4	CH1	CH2	Teža [g]	Tip
	5/3	R1/8"	8	17	21,5	38,5	8	8	19	SC24C-05-18-N
6/4	R1/8"	8	17	22,5	39,5	12	8	26	SC24C-06-18-N	
6/4	R1/4"	11	20	22,5	42,5	12	10	34	SC24C-06-14-N	
8/6	R1/8"	8	17,5	22,5	40,5	14	10	37	SC24C-08-18-N	
8/6	R1/4"	11	20,5	22,5	43,5	14	10	40	SC24C-08-14-N	
10/8	R1/4"	11	21	25,5	46,5	16	11	48	SC24C-10-14-N	
10/8	R3/8"	11,5	22,5	25,5	48	16	11	51	SC24C-10-38-N	
12/10	R3/8"	11,5	24,5	30	54,5	18	14	72	SC24C-12-38-N	
12/10	R1/2"	14	28	30,5	58,5	18	17	100	SC24C-12-12-N	
15/12,5	R1/2"	14	28	34	62	22	17	113	SC24C-15-12-N	

### SC27 Prehodni vijačni priključek, Tlak -1...25bar

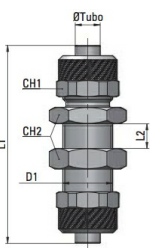
	Premer cevi D / d [mm]	D1	L1	L2	CH1	CH2	Teža [g]	Tip
	5/3	M7x0,75	40	8,5	8	9	12	SC27-05-N
6/4	M10x1	48	10,5	12	14	33	SC27-06-N	
8/6	M12x1	48	10,5	14	16	43	SC27-08-N	
10/8	M14x1	50	8,5	16	17	53	SC27-10-N	
12/10	M16x1	53	8,5	18	19	76	SC27-12-N	
15/12,5	M20x1	58	8,5	22	24	105	SC27-15-N	

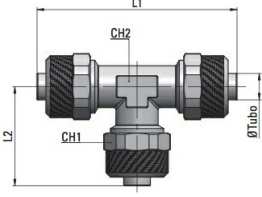

### SC29 T-spojnik, Tlak -1...25bar

	Premer cevi D / d [mm]	L1	L2	CH1	CH2	Teža [g]	Tip
	5/3	43	21,5	8	8	17	SC29-05-N
6/4	45	22,5	12	8	32	SC29-06-N	
8/6	45	22,5	14	10	42	SC29-08-N	
10/8	51	25,5	16	11	55	SC29-10-N	
12/10	60	30	18	14	85	SC29-12-N	
15/12,5	68	34	22	17	124	SC29-15-N	

### SC32 prekrivna matica z Zaščitna spirala proti pregibanju, Tlak -1...25bar

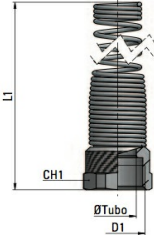
	Premer cevi D / d [mm]	D1	L1	CH1	Teža [g]	Tip
	6/4	M10x1	95	12	14	SC32-06-N-YA
8/6	M12x1	93,5	14	18	SC32-08-N-YA	
10/8	M14x1	96,5	16	22	SC32-10-N-YA	
12/10	M16x1	112	15	31	SC32-12-N	

### SC33 prekrivna matica, Tlak -1...25bar

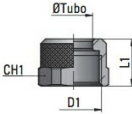
	Premer cevi D / d [mm]	D1	L1	CH1	Teža [g]	Tip
	4/2,5	M6x0,75	8	7	1	SC33-04-M6X0,75-N
5/3	M7x0,75	8,5	8	1	SC33-05-M7X0,75-N	
6/4	M8x0,75	9	9	2	SC33-06-M8X0,75-N	
6/4	M10x1	10,5	12	4	SC33-06-M10X1-N	
8/6	M12x1	10,5	14	5	SC33-08-M12X1-N	
10/8	M14x1	11,5	16	7	SC33-10-M14X1-N	
12/10	M16x1	13	18	12	SC33-12-M16X1-N	
15/12,5	M20x1	15,5	22	16	SC33-15-M20X1-N	

### SC35 L-obročni kos, Tlak -1...18bar

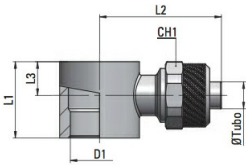
	Premer cevi D / d [mm]	D1	L1	L2	L3	CH1	Teža [g]	Tip
	4/2,5	M5	9	19	4,5	7	7	SC35-04-M5-N
4/2,5	M5	10	19	3,5	7	6	SC35-04-M5-N-M*	
4/2,5	G1/8"	15	21,5	6	7	13	SC35-04-18-N	
5/3	M5	9	19	4,5	8	7,5	SC35-05-M5-N	
5/3	M5	10	19	4	8	6,5	SC35-05-M5-N-M*	
5/3	1/8"	15	25	6	12	20	SC35-05-18-N	
6/4	M5	9	19	4	9	9	SC35-06-M5-N	
6/4	M5	10	19	4,5	9	7	SC35-06-M5-N-M*	
6/4	1/8"	15	25	6	12	19	SC35-06-18-N	
6/4	1/4"	17	26,5	7,5	12	25	SC35-06-14-N	
8/6	1/8"	15	25	6	14	19	SC35-08-18-N	
8/6	1/4"	17	27,5	7,5	14	27	SC35-08-14-N	
8/6	3/8"	20	29,5	7,5	14	39	SC35-08-38-N	
10/8	1/4"	17	28,5	7,5	16	30	SC35-10-14-N	
10/8	3/8"	20	30,5	7,5	16	41	SC35-10-38-N	

\*za Dušilni ventil z vrtljivim priključkom in Dušilno nepovratni ventil z vrtljivim priključkom

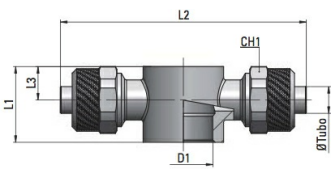

### SC36 T-obročni kos, Tlak -1...18bar

	Premer cevi D / d [mm]	D1	L1	L2	L3	CH1	Teža [g]	Tip
	5/3	M5	9	34	4,5	8	12	SC36-05-M5-N
5/3	1/8"	15	50	6	12	32	SC36-05-18-N	
6/4	M5	9	34	4,5	9	13	SC36-06-M5-N	
6/4	1/8"	15	50	6	12	30	SC36-06-18-N	
6/4	1/4"	17	53	7,5	12	36	SC36-06-14-N	
8/6	1/8"	15	50	6	14	30	SC36-08-18-N	
8/6	1/4"	17	55	7,5	14	39	SC36-08-14-N	
8/6	3/8"	20	59	7,5	14	52	SC36-08-38-N	
10/8	1/4"	17	57	7,5	16	45	SC36-10-14-N	
10/8	3/8"	20	61	7,5	16	56	SC36-10-38-N	

### SC40 Zapiralni pokrovček

	Premer cevi D / d [mm]	Višina	max. Tlak 20°C	max. Tlak 30°C	max. Tlak 60°C	max. Tlak 80°C	Tip
	5/3	11	16	16	16	12	SC40-05-DA
6/4	23	13	10	6	3	SC40-06-D	
8/6	23	8	6	3	2	SC40-08-D	

Slike niso zavezujoče

Pridržujemo si pravico do sprememb konstrukcije, mer in materialov

Pnevmatika / Vezni elementi in spojke / Navojni cevni priključki / Navojni cevni priključki - ponikljana medenina tlak -1...18bar/25bar

