

3/2-Way solenoid valve - pilot-operated - NAMUR Series NM32W

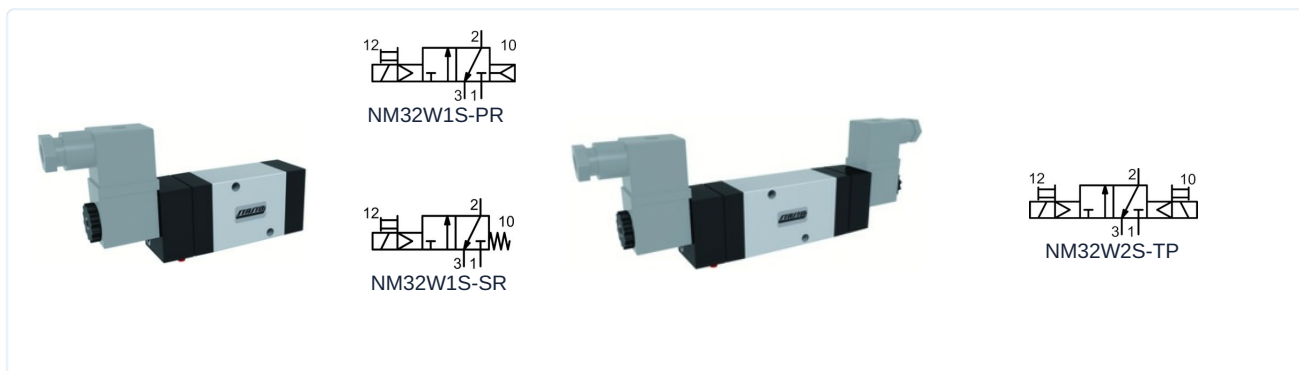

Design type	3/2-way solenoid valve pilot-operated, Actuation electric/internal pilot air, electric/spring or rather electric/electric, Manual emergency override
Connection	G1/4" according to ISO228/1
Materials	Body Aluminium, Slide valve Nickel-plated aluminium, Cover Plastic, Seals NBR
Medium	filtered and lubricated or non-lubricated compressed air
Medium temperature	0...+40°C
Ambient temperature	-10...+50°C
Mounting type	via two mounting screws according to NAMUR standard and VDI/VDE 3845
Mounting position	any

Electrical data:

Coil type	Type C001 (Standard coil), Connector width 22mm Type EPC (ATEX coil)
Electrical connection	Appliance socket according to industrial form B Cable entry M16x1,5; Coil type EPC with 3 m cable (see separate data sheet)
Standard voltage	230V/50-60Hz, 24V/50-60Hz / 12VDC, 24VDC / 48V/50-60Hz
Special voltages	115V/50-60Hz, further on request
Permissible voltage fluctuation	± 10%
Power consumption	see table "Solenoid coil"
Duty cycle	100% duty cycle (continuous operation)
Degree of protection	IP65 according to EN 60529 with correctly mounted device connector (Protection against dust ingress and water jets)

Notes:

When ordering, please specify voltage and type of current CAD files are available in the STASTO Store at www.stasto.eu
--

Type code

NM32W1S-	SR	C001-	230V/50-60Hz
	PR electric/internal pilot air	C001 Standard coil	230V/50-60Hz
	SR electric/spring	EPCATEX coil	115V/50-60Hz
			24V/50-60Hz
			24VDC
			12VDC



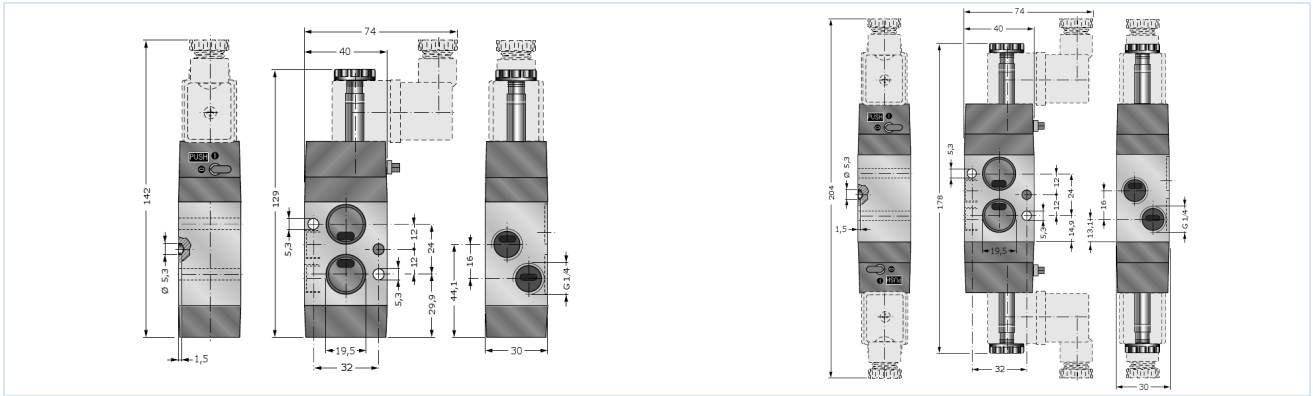

Nominal size DN [mm]	Pressure range [bar]	Flow rate [NI/min] *	Type
8	2,5-10	1080	NM32W1S-SR
8	2,2-10	1080	NM32W1S-PR
8	1,5-10	1080	NM32W2S-TP

*Reference pressure 6bar, Reference temperature 20°C

Flow diagram

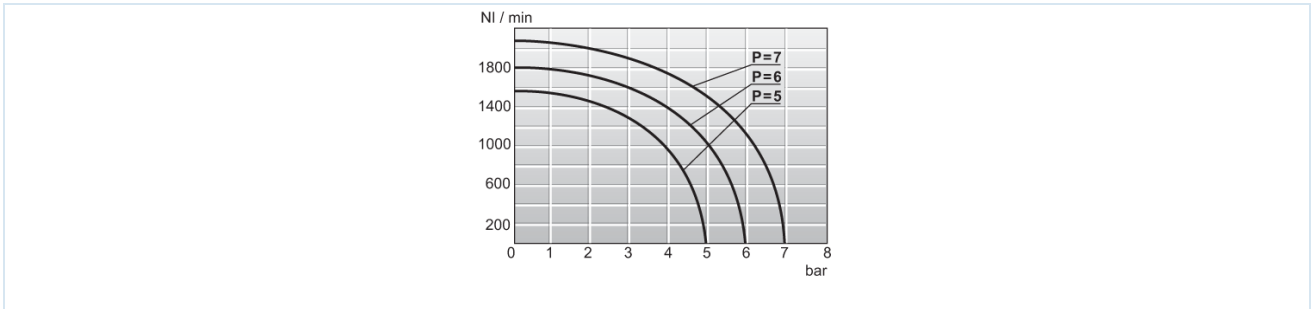



Switching time, nominal max. frequency

Switching time [ms]								nominal max. frequency [Hz]			
NM32W1S-SR				NM32W1S-PR				NM32W1S-SR		NM32W1S-PR	
AC ONE	AC EXHAUST	DC ONE	DC EXHAUST	AC ONE	AC EXHAUST	DC ONE	DC EXHAUST	AC	DC	AC	DC
19	35	21	46	18	33	21	44	11	11	16	13

Switching time [ms]				nominal max. frequency [Hz]	
NM32W2S-TP				NM32W2S-TP	
AC ONE	AC EXHAUST	DC ONE	DC EXHAUST	AC	DC
11	11	14	14	27	21

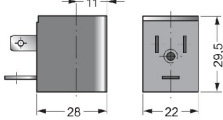
Solenoid coils

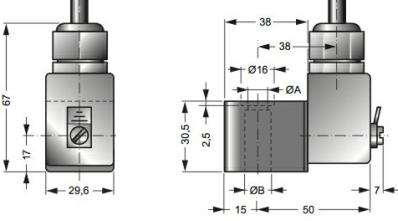
		Voltage	Degree of protection	Power consumption at 20°C	Type
		24VDC / 48V/50-60Hz	IP65	3W/5VA	C001-03
		24V/50-60Hz / 12VDC		5VA/3W	C001-04
		230V/50-60Hz		5VA	C001-22
		115V/50-60Hz		5VA	C001-23
		24VDC	Ex II 2G Ex mb IIC T5 Gb Ex II 2D Ex mb tb IIIC T95°C IP66 Db	3,0W	EPC02400
		24V/50-60Hz		3,2W	EPC02450
		110V/50-60Hz		3,2W	EPC11050
		230V/50-60Hz		3,2W	EPC23050

Illustrations non-binding

Design, dimensional and material changes reserved

[Pneumatics](#) / [Way-valves - electrically / pneumatically](#) / [3/2- 5/2-way valves - NAMUR](#) / [3/2-way valve Series NM](#)

