

Magneetcilinder zonder zuigerstang met toebehoren Serie RLF



Constructie	Magneetcilinder zonder zuigerstang
Koppen	Aluminium hard geanodiseerd
Slede	Aluminium hard geanodiseerd
Cilinderbuis	Aluminiumprofiel hard geanodiseerd
Afdichtbanden	Roestvrij staal
Afdichtingen	Zuigersnelheid < 1m/s NBR, Zuigersnelheid ≥ 1m/s FKM
Einddemping	pneumatisch, instelbaar
Omgevingstemperatuur	-10...+80°C
Mediumtemperatuur	0...+40°C
Smearing	niet noodzakelijk
Medium	gefilterde perslucht
Bedrijfsdruk	0,5...8bar
Speciale uitvoering	alle schroeven in roestvast staal, ATEX II 2G EX h IIB T4 Gb -10°C < Ta < +80°C en II 2D EX h IIIC T 130°C Db
Opmerking	CAD-bestanden zijn verkrijgbaar in de STASTO Store op www.stasto.eu Magneetschakelaar zie eigen gegevensblad

Typecode

RLF-	16 -	100 -	V
	16 ø16	Slag [mm]	Østandaard
	25 ø25	ø16: 100...3300 mm	V FKM-Afdichtingen
	32 ø32	ø25...ø63: 100...5700 mm	X Roestvaststalen schroeven
	40 ø40		VX Viton-afdichtingen, Roestvaststalen schroeven
	50 ø50		
	63 ø63		



Afmetingen

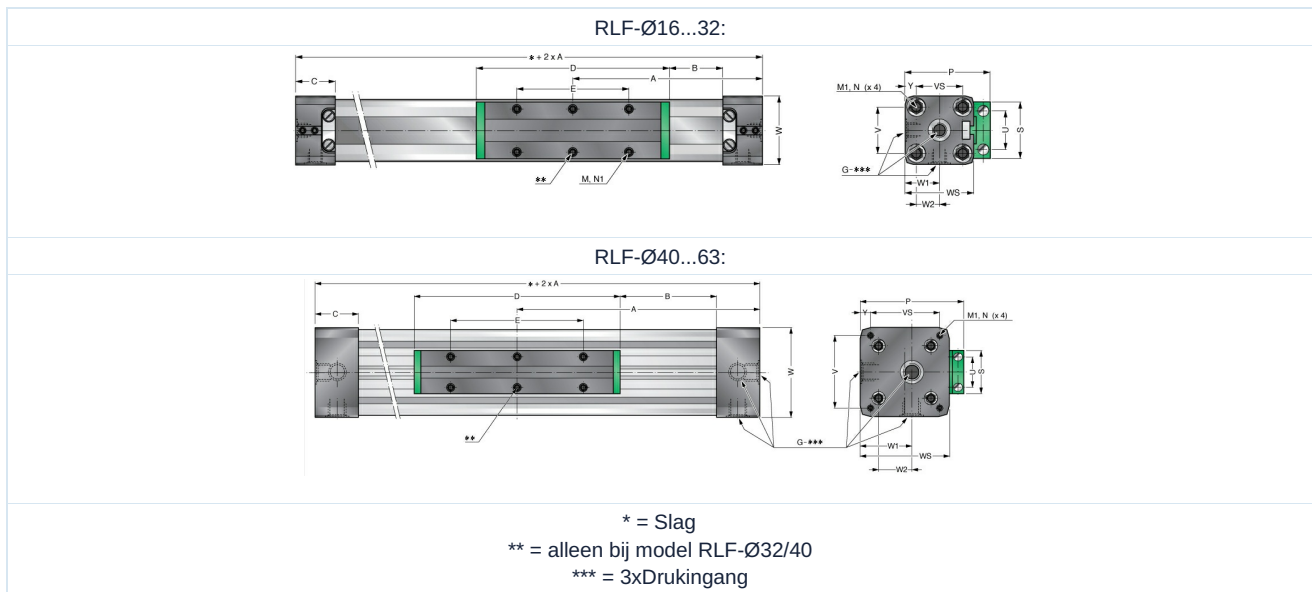

Ø	A	B	C	D	E	G	M	M1	N	N1	P	S	U	V	VS	W	WS	W1	W2	Y	Dempingslengte	Type
16	65	15,5	15	69	36	M5	M4	M3	7	7	36,5	22	16,5	18	18	27	27	13,5	17,1	4,5	15	RLF-16-.....
25	100	21	23	111	65	G1/8	M5	M5	12	10	52,5	33	25	27	27	40	40	20	25,8	6,5	21	RLF-25-.....
32	125	22	27	152	90	G1/4	M6	M6	14	7	66,5	36	27	36	40	52	56	30	39	8	26	RLF-32-.....
40	150	44	30	152	90	G1/4	M6	M6	17	10	80	36,4	27	54	54	72	69	36	48,8	9	32	RLF-40-.....
50	175	42	33	200	110	G1/4	M6	M6	18	16	89	56	27	70	70	80	80	44,5	44,5	5	32	RLF-50-.....
63	215	47,5	50	235	155	G3/8	M8	M8	18	15	123	50	36	78	78	106	106	62,5	48,8	14,5	40	RLF-63-.....

Dempingsdiagramma

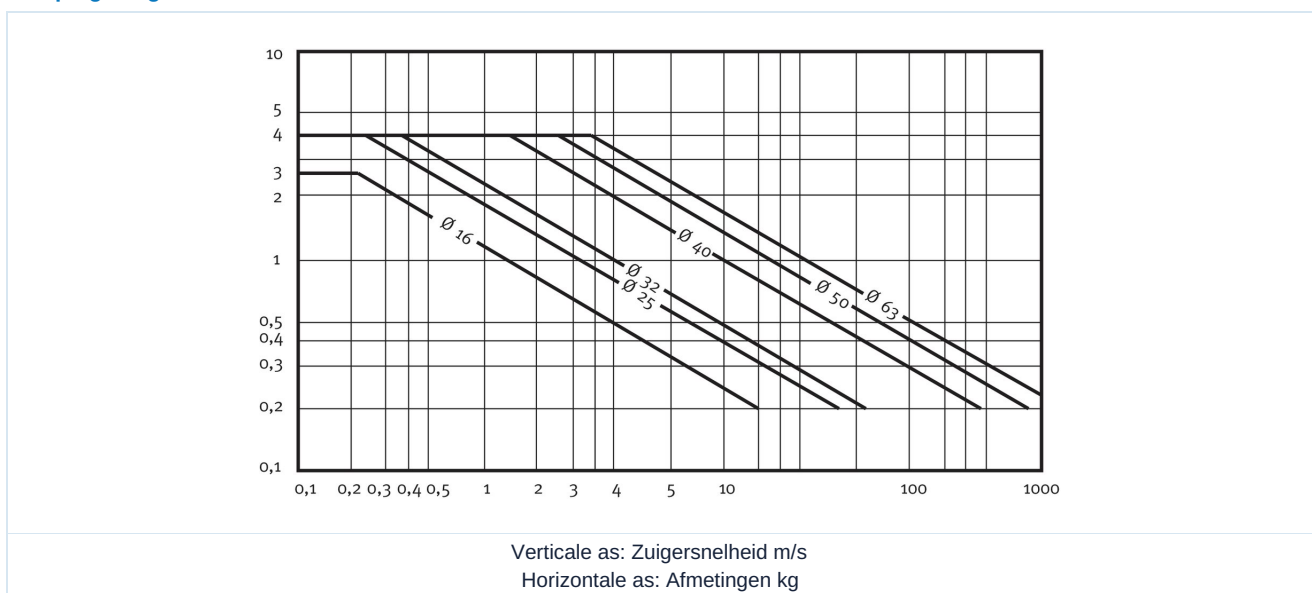

Dwarskracht

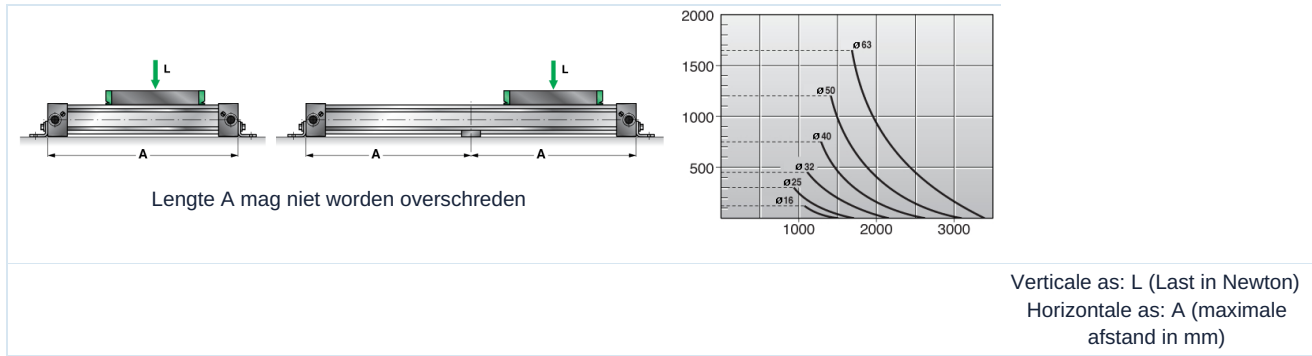

Krachten en draaimomenten

De opgegeven waarden zijn maximale waarden onder de voorwaarde van geringe stootbelasting en een snelheid van 0,45m/s. Maximale druk 6bar. Een verhoging van de waarden in dynamische functie, ook al is dit slechts kortstondig, moet worden vermeden. Let op: Resulterende krachten kunnen leiden tot een sterke verhoging van de waarden. In geval van een niet-definieerbare situatie moeten de opgegeven maximale waarden met 20% worden vermindert.

Ø	Langskracht [N] bij 6bar	Maximale belasting L [N]	Ma axiaal [Nm]	Mr radiaal [Nm]	Mv centraal [Nm]
16	110	120	4	0,3	0,5
25	250	300	15	1	3
32	420	450	30	2	4,5
40	640	750	60	4	8
50	1000	1200	115	7	15
63	1550	1650	200	8	24

Toebehoren

RLP - .. Voetbevestiging

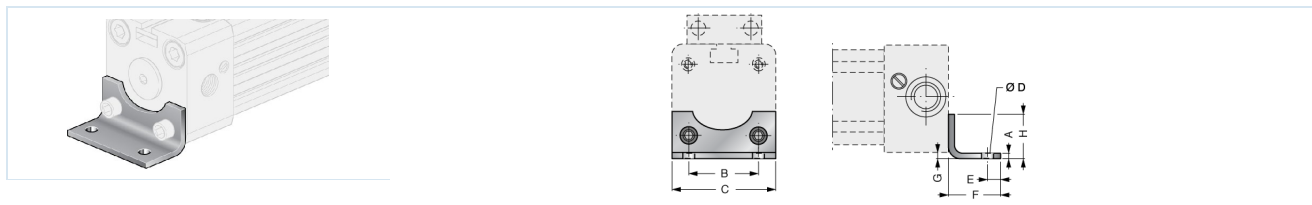

Ø	A	B	C	ØD	E	F	G	H	Type
16	1,5	18	26	3,6	4	14	1,5	12,5	RLP-16
25	2,5	27	40	5,5	6	22	2	18	RLP-25

RLQ - .. Voetbevestiging

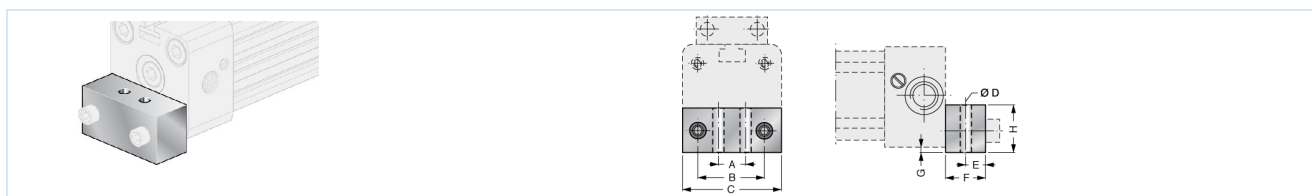

Ø	A	B	C	ØD	E	F	G	H	Type
32	20	36	51	6,5	8	24	4	20	RLQ-32
40	30	54	71	9	11,5	24	2	20	RLQ-40
50	45	70	80	9	12,5	25	1	25	RLQ-50
63	48	78	105	11	15	30	2	40	RLQ-63



RLMI - .. Lagerblokken

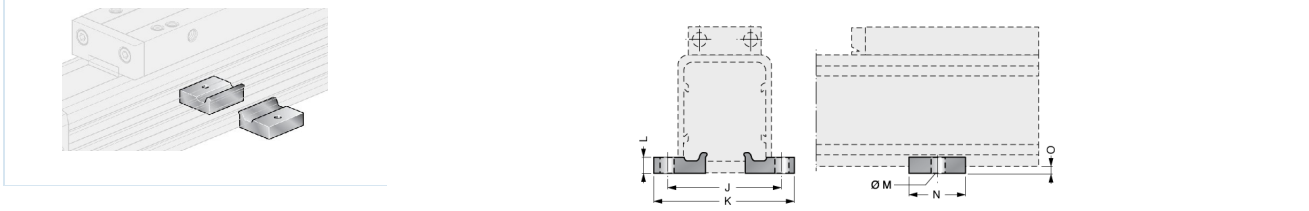

Ø	J	K	L	ØM	N	O	Type
16	41,5	53,5	5	5,5	20	3	RLMI-16
25	48,5	60	6	5,5	20	4	RLMI-25

RLML - .. Lagerblokken

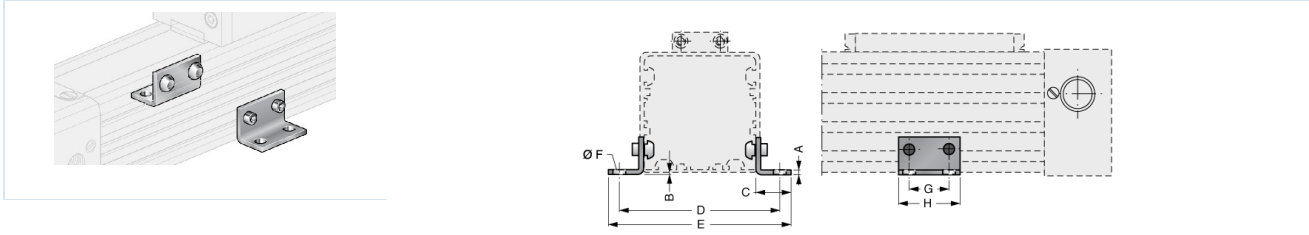

Ø	A	B	C	D	E	ØF	G	H	Type
32	5	6	20	82	91	4,5	30	45	RLML-32
40	5	8,5	20	90	99	4,5	30	45	RLML-40
50	5	1	35	123	148	6,5	30	45	RLML-50
63	5	3,5	35	147	172	6,5	30	45	RLML-63

Afbeeldingen niet bindend
 Constructie-, maat- en materiaalwijzigingen voorbehouden

[Pneumatiek](#) / [Arbeidselementen](#) / [Stangloze cilinders met toebehoren](#) / [Lagerblok Serie RLMI](#)

