

## Vijčani priključci - Niklovani mesing Serija SC

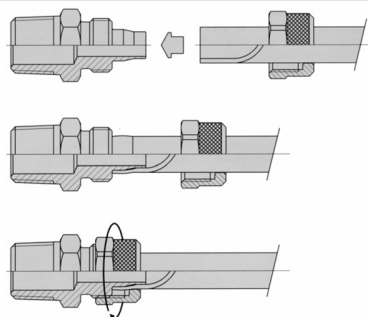

Izvedba	Vijčani spoj s preklapnom maticom
Priključak	1/8"....1/2" po izboru cilindrični prema ISO 228/1 ili konusni prema ISO 7/1, M5 prema ISO R/262
Vanjski promjer cijevi	4...15 mm
Materijali	Niklovani mesing
preporučeno Materijali cijevi	Poliamid (PA), Poliuretan (PU/CP), Polietilen (PE), PTFE (PT)
Tolerancije cijevi	+/- 0,05mm do promjera 10mm, +/- 0,1mm od promjera 12mm
Medij	Stlačeni zrak, neutralni plinovi
Temperatura medija	-20...+70°C (-40...+150°C na upit)
Radni tlak	-1...18bar odnosno -1...25bar, ovisno o maksimalnom tlaku upotrijebljene cijevi

### Upute za montažu



1. Odrezati crijevo pod pravim kutom
2. Navući preklapnu maticu na crijevo
3. Crijevo i preklapnu maticu gurnuti preko konusa crijeva do graničnika
4. Preklapnu maticu zategnuti rukom ili, ako je potrebno, ključem



### SC12 Ravna uvrnuta priključnica - Cilindrični navoj, Tlak -1...18bar

Promjer cijevi D / d [mm]	D1	L1	L2	CH1	CH2	Težina [g]	Tip
4/2,5	M5x0,8	5	20	7	7	3,5	SC12-04-M5-N-D
4/2,5	G1/8"	6	22,5	7	14	10	SC12-04-18-N-D
5/3	M5x0,8	4	20	8	8	5	SC12-05-M5-N-0
5/3	G1/8"	6	23	8	14	14,5	SC12-05-18-N-0
6/4	M5x0,8	4	21	9	8	6	SC12-06-M5-N-0
6/4	M12x1,25	8	28	12	17	21	SC12-06-12X1,25-N-D
6/4	M12x1,5	8	28	12	17	21	SC12-06-12X1,5-N-D
6/4	G1/8"	5,5	23,5	10	14	16	SC12-06-18-N-0
6/4	G1/4"	6,5	25,5	10	16	24	SC12-06-14-N-0
6/4	G3/8"	9	28	10	19	28	SC12-06-38-N-0
6/4	G1/2"	10	30	10	24	37	SC12-06-12-N-0
8/6	G1/8"	5,5	23	12	14	19	SC12-08-18-N-0
8/6	G1/4"	6,5	25,5	12	16	25	SC12-08-14-N-0
8/6	G3/8"	9	28	12	19	30	SC12-08-38-N-0
8/6	G1/2"	10	30	12	24	40	SC12-08-12-N-0
10/8	G1/8"	5,5	26,5	14	14	23	SC12-10-18-N-0
10/8	G1/4"	6,5	28,5	14	16	29	SC12-10-14-N-0
10/8	G3/8"	9	30	14	19	32	SC12-10-38-N-0
10/8	G1/2"	10	32	14	24	45	SC12-10-12-N-0
12/10	G3/8"	9	30,5	15	19	39	SC12-12-38-N-0
12/10	G1/2"	10	32,5	15	24	53	SC12-12-12-N-0
15/12,5	G1/2"	10	34,5	22	24	58	SC12-15-12-N-0

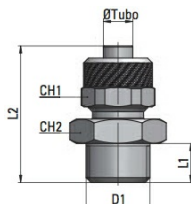

### SC12C Ravna uvrnuta priključnica - Konični navoj, Tlak -1...25bar

Promjer cijevi D / d [mm]	D1	L1	L2	CH1	CH2	Težina [g]	Tip
4/2,5	R1/8"	7,5	23,5	7	11	7	SC12C-04-18-N
5/3	R1/8"	8	25	8	12	9	SC12C-05-18-N
6/4	R1/8"	8	27,5	12	12	18	SC12C-06-18-N
6/4	R1/4"	11	31	12	14	21	SC12C-06-14-N
6/4	R3/8"	11,5	31,5	12	17	25	SC12C-06-38-N
8/6	R1/8"	8	27,5	14	12	18	SC12C-08-18-N
8/6	R1/4"	11	31	14	14	23	SC12C-08-14-N
8/6	R3/8"	11,5	31,5	14	17	29	SC12C-08-38-N
10/8	R1/8"	8	29,5	16	14	22	SC12C-10-18-N
10/8	R1/4"	11	32,5	16	14	27	SC12C-10-14-N
10/8	R3/8"	11,5	33	16	17	34	SC12C-10-38-N
10/8	R1/2"	14	36	16	22	48	SC12C-10-12-N
12/10	R3/8"	11,5	34,5	18	17	37	SC12C-12-38-N
12/10	R1/2"	14	37,5	18	22	50	SC12C-12-12-N
15/12,5	R1/2"	14	39,5	22	22	62	SC12C-15-12-N

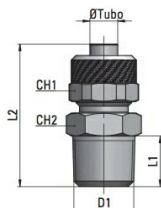

### SC12C Okretni, ravni uvrtni priključak - Konični navoj, Tlak -1...18bar

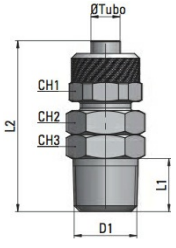
	Promjer cijevi D / d [mm]	D1	L1	L2	CH1	CH2	CH3	Težina [g]	Tip
	6/4	R1/8"	8	37	12	12	12	22	SC12C-06-18-N-360YA
6/4	R1/4"	11	40	12	14	14	28	SC12C-06-14-N-360YA	
8/6	R1/8"	8	37	14	12	12	26	SC12C-08-18-N-360YA	
8/6	R1/4"	11	40	14	14	14	30	SC12C-08-14-N-360YA	
10/8	R1/4"	11	42	16	14	14	34	SC12C-10-14-N-360	
10/8	R3/8"	11,5	39	16	14	17	43	SC12C-10-38-N-360	

### SC13 Ravna navojna priključnica, Tlak -1...25bar

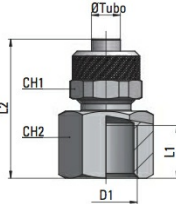
	Promjer cijevi D / d [mm]	D1	L1	L2	CH1	CH2	Težina [g]	Tip
	5/3	G1/8"	8	22,5	8	14	13	SC13-05-18-N
6/4	G1/4"	11	29	12	17	26	SC13-06-14-N	
8/6	G1/8"	8	25	14	14	22	SC13-08-18-N	
8/6	G1/4"	11	29	14	17	29	SC13-08-14-N	
8/6	G3/8"	11,5	29,5	14	20	31	SC13-08-38-N	
8/6	G1/2"	15	33	12	24	61	SC13-08-12-N	
10/8	G1/4"	11	30,5	16	17	32	SC13-10-14-N	
10/8	G3/8"	11,5	31	16	20	38	SC13-10-38-N	
12/10	G3/8"	11,5	32,5	18	20	54	SC13-12-38-N	

### SC13 Ravni spojnik, Tlak -1...25bar

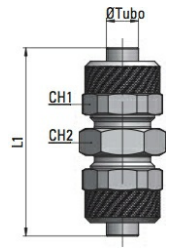
	Promjer cijevi D1 [mm]	Promjer cijevi D2 [mm]	L1	CH1	CH2	Težina [g]	Tip
	5/3	5/3	28,5	8	8	8	SC13-05-N
6/4	6/4	34,5	12	12	21	SC13-06-N	
8/6	8/6	35	14	14	25	SC13-08-N	
10/8	10/8	38	16	14	38	SC13-10-N	
12/10	12/10	41	18	17	47	SC13-12-N	
15/12,5	15/12,5	45,5	22	22	83	SC13-15-N	

### SC14 Okretni kutni uvrtni priključak, Tlak -1...18bar

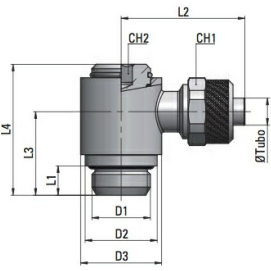
	Promjer cijevi D / d [mm]	D1	D2	D3	L1	L2	L3	L4	CH1	CH2	Težina [g]	Tip
	6/4	G1/8"	14	14	5	25	16,5	25,5	12	4	27	SC14-06-18-N-0-360
6/4	G1/4"	16	18	6,5	26,5	19	29	12	5	42	SC14-06-14-N-0-360	
8/6	G1/8"	14	14	5	25	16,5	25,5	14	4	29	SC14-08-18-N-0-360	
8/6	G1/4"	16	18	6,5	27,5	19	29	14	5	44	SC14-08-14-N-0-360	
10/8	G1/4"	16	18	6,5	28,5	19	29	16	5	46	SC14-10-14-N-0-360	
10/8	G3/8"	21	18	7	30,5	23,5	32,5	16	8	69	SC14-10-38-N-0-360	

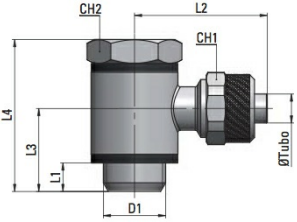

### SC14 L-zakretni priključak, Tlak -1...18bar

	Promjer cijevi D / d [mm]	D1	L1	L2	L3	L4	CH1	CH2	Težina [g]	Tip
	4/2,5	M5x0,8	4	19	9,5	19	7	8	9	SC14-04-M5-N
4/2,5	G1/8"	6	21,5	16,5	27	7	14	28	SC14-04-18-N	
5/3	M5x0,8	4	19	9,5	19	8	8	11	SC14-05-M5-N	
5/3	G1/8"	6	25	16,5	27	8	14	27	SC14-05-18-N	
6/4	M5x0,8	4	19	9,5	19	9	8	11	SC14-06-M5-N	
6/4	G1/8"	6	25	16,5	27	12	14	32	SC14-06-18-N	
6/4	G1/4"	8	26,5	19,5	31,5	12	17	52	SC14-06-14-N	
8/6	G1/8"	6	25	16,5	27	14	14	34	SC14-08-18-N	
8/6	G1/4"	8	27,5	19,5	31,5	14	17	55	SC14-08-14-N	
8/6	G3/8"	9	29,5	23,5	36	14	20	82	SC14-08-38-N	
10/8	G1/4"	8	28,5	19,5	31,5	16	17	57	SC14-10-14-N	
10/8	G3/8"	9	30,5	23,5	36	16	20	85	SC14-10-38-N	

### SC16 Okretni kutni uvrtni priključak - Cilindrični navoj, Tlak -1...18bar

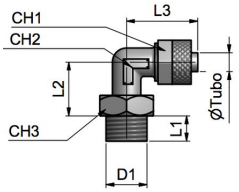
	Promjer cijevi D / d [mm]	D1	L1	L2	L3	CH1	CH2	CH3	Težina [g]	Tip
	6/4	G1/8"	6	16	22,5	12	8	14	23	SC16-06-18-N-0-360
6/4	G1/4"	8	17	23	12	10	17	35	SC16-06-14-N-0-360	
8/6	G1/8"	6	15	23	14	10	14	29	SC16-08-18-N-0-360	
8/6	G1/4"	8	17	23	14	10	17	36	SC16-08-14-N-0-360	
10/8	G1/4"	8	18	25	16	11	17	43	SC16-10-14-N-0-360	

### SC16C Kutni uvrtni priključak - Konični navoj, Tlak -1...25bar

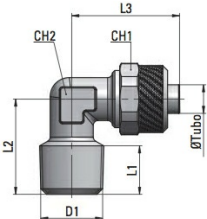
	Promjer cijevi D / d [mm]	D1	L1	L2	L3	CH1	CH2	Težina [g]	Tip
	4/2,5	M5x0,8	5	15,5	20	7	9	10	SC16C-04-M5-N
4/2,5	R1/8"	7,5	17	20	7	9	11	SC16C-04-18-N	
5/3	R1/8"	8	17	21,5	8	8	11	SC16C-05-18-N	
6/4	M12x1,25	9	21	22,5	12	10	23	SC16C-06-M12X1,25-N	
6/4	M12x1,5	9	21	22,5	12	10	19	SC16C-06-M12X1,5-N	
6/4	R1/8"	8	17	22,5	12	8	16	SC16C-06-18-N	
6/4	R1/4"	11	20	22,5	12	10	22	SC16C-06-14-N	
6/4	R3/8"	11,5	22,5	23,5	12	11	30	SC16C-06-38-N	
8/6	R1/8"	8	17	22,5	14	10	20	SC16C-08-18-N	
8/6	R1/4"	11	20	22,5	14	10	23	SC16C-08-14-N	
8/6	R3/8"	11,5	22,5	24	14	11	31	SC16C-08-38-N	
10/8	R1/8"	8	18,5	25,5	16	11	28	SC16C-10-18-N	
10/8	R1/4"	11	21,5	25,5	16	11	31	SC16C-10-14-N	
10/8	R3/8"	11,5	22,5	25,5	16	11	36	SC16C-10-38-N	
10/8	R1/2"	14	28	25,5	16	17	40	SC16C-10-12-N	
12/10	R3/8"	11,5	24,5	30	18	14	46	SC16C-12-38-N	
12/10	R1/2"	14	28	30,5	18	17	60	SC16C-12-12-N	
15/12,5	R1/2"	14	28	34	22	17	69	SC16C-15-12-N	

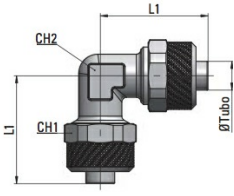

### SC17 Kutni spojnik, Tlak -1...25bar

	Promjer cijevi D / d [mm]	L1	L2	CH1	CH2	Težina [g]	Tip
	5/3	21,5	21,5	8	8	13	SC17-05-N
6/4	21,5	21,5	12	8	23	SC17-06-N	
8/6	22,5	22,5	14	10	28	SC17-08-N	
10/8	25,5	25,5	16	11	38	SC17-10-N	
12/10	30	30	18	14	60	SC17-12-N	
15/12,5	34	34	22	17	84	SC17-15-N	

### SC17 Kutni priključak s navojem za uvrćivanje, Tlak -1...25bar

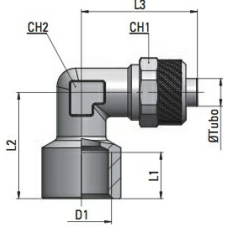
	Promjer cijevi D / d [mm]	D1	L1	L2	L3	CH1	CH2	Težina [g]	Tip
	5/3	G1/8"	8	19	21,5	8	10	21	SC17-05-18-N
6/4	G1/8"	8	19	22,5	12	10	21	SC17-06-18-N	
6/4	G1/4"	10,5	23	25	12	11	30	SC17-06-14-N	
8/6	G1/8"	8	19	22,5	14	10	28	SC17-08-18-N	
8/6	G1/4"	10,5	23	25	14	11	31	SC17-08-14-N	
10/8	G1/4"	11	23,5	26	16	13	33	SC17-10-14-N	
12/10	G3/8"	11,5	28	30,5	18	17	70	SC17-12-38-N	

### SC20 Križni spojnik, Tlak -1...25bar

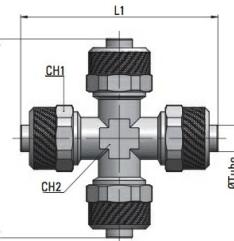
	Promjer cijevi D / d [mm]	L1	L2	CH1	CH2	Težina [g]	Tip
	5/3	43	43	8	8	45	SC20-05-N
6/4	45	45	12	8	45	SC20-06-N	
8/6	45	45	14	10	52	SC20-08-N	
10/8	51	51	16	11	72	SC20-10-N	

### SC21C T-navojni priključak - Konični navoj, Tlak -1...25bar

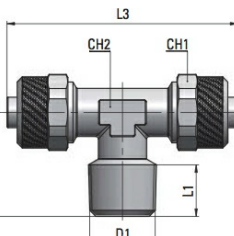
	Promjer cijevi D / d [mm]	D1	L1	L2	L3	CH1	CH2	Težina [g]	Tip
	5/3	R1/8"	8	17	43	8	8	18	SC21C-05-18-N
6/4	R1/8"	8	17	45	12	8	26	SC21C-06-18-N	
6/4	R1/4"	11	20,5	45,5	12	10	35	SC21C-06-14-N	
8/6	R1/8"	8	17,5	45,5	14	10	34	SC21C-08-18-N	
8/6	R1/4"	11	20,5	45,5	14	10	41	SC21C-08-14-N	
10/8	R1/4"	11	21,5	51	16	11	47	SC21C-10-14-N	
10/8	R3/8"	11,5	22,5	51	16	11	51	SC21C-10-38-N	
12/10	R3/8"	11,5	24,5	60	18	14	75	SC21C-12-38-N	
12/10	R1/2"	14	28	61	18	17	100	SC21C-12-12-N	
15/12,5	R1/2"	14	28	68	22	17	102	SC21C-15-12-N	

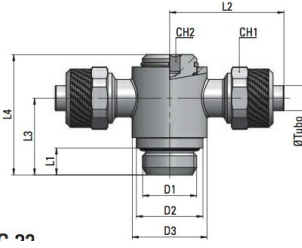

### SC22 Okretni T-navojni priključak, Tlak -1...18bar

	Promjer cijevi D / d [mm]	D1	D2	D3	L1	L2	L3	L4	CH1	CH2	Težina [g]	Tip
	6/4	G1/8"	14	14	5	25	16,5	25,5	12	4	39	SC22-06-18-N-0-360
6/4	G1/4"	16	18	6,5	26,5	19	29	12	5	53	SC22-06-14N-0-360	
8/6	G1/8"	14	14	5	25	16,5	25,5	14	4	41	SC22-08-18N-0-360	
8/6	G1/4"	16	18	6,5	27,5	19	29	14	5	57	SC22-08-14N-0-360	
10/8	G1/4"	16	18	6,5	28,5	19	29	16	5	64	SC22-10-14N-0-360	
10/8	G3/8"	21	22	7	30,5	23,5	32,5	16	8	85	SC22-10-38N-0-360	

### SC22 T-zakretni priključak, Tlak -1...18bar

	Promjer cijevi D / d [mm]	D1	L1	L2	L3	L4	CH1	CH2	Težina [g]	Tip
	5/3	M5x0,8	4	17	9,5	19	8	8	15	SC22-05-M5-N
5/3	G1/8"	6	25	16,5	27	8	14	45	SC22-05-18-N	
6/4	M5x0,8	4	17	9,5	19	9	8	16	SC22-06-M5-N	
6/4	G1/8"	6	25	16,5	27	12	14	45	SC22-06-18-N	
6/4	G1/4"	8	26,5	19,5	31,5	12	17	63	SC22-06-14-N	
8/6	G1/8"	6	25	16,5	27	14	14	46	SC22-08-18-N	
8/6	G1/4"	8	27,5	19,5	31,5	14	17	67	SC22-08-14-N	
8/6	G3/8"	9	29,5	23,5	36	14	20	96	SC22-08-38-N	
10/8	G1/4"	8	28,5	19,5	31,5	16	17	72	SC22-10-14-N	
10/8	G3/8"	9	30,5	23,5	36	16	20	103	SC22-10-38-N	

### SC24C T-navojni priključak - Konični navoj, Tlak -1...25bar

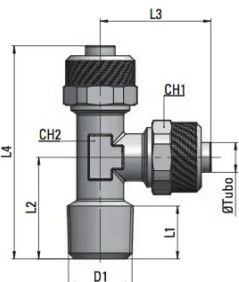
	Promjer cijevi D / d [mm]	D1	L1	L2	L3	L4	CH1	CH2	Težina [g]	Tip
	5/3	R1/8"	8	17	21,5	38,5	8	8	19	SC24C-05-18-N
6/4	R1/8"	8	17	22,5	39,5	12	8	26	SC24C-06-18-N	
6/4	R1/4"	11	20	22,5	42,5	12	10	34	SC24C-06-14-N	
8/6	R1/8"	8	17,5	22,5	40,5	14	10	37	SC24C-08-18-N	
8/6	R1/4"	11	20,5	22,5	43,5	14	10	40	SC24C-08-14-N	
10/8	R1/4"	11	21	25,5	46,5	16	11	48	SC24C-10-14-N	
10/8	R3/8"	11,5	22,5	25,5	48	16	11	51	SC24C-10-38-N	
12/10	R3/8"	11,5	24,5	30	54,5	18	14	72	SC24C-12-38-N	
12/10	R1/2"	14	28	30,5	58,5	18	17	100	SC24C-12-12-N	
15/12,5	R1/2"	14	28	34	62	22	17	113	SC24C-15-12-N	

### SC27 Pregradna spojnica, Tlak -1...25bar

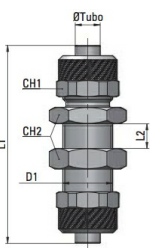
	Promjer cijevi D / d [mm]	D1	L1	L2	CH1	CH2	Težina [g]	Tip
	5/3	M7x0,75	40	8,5	8	9	12	SC27-05-N
6/4	M10x1	48	10,5	12	14	33	SC27-06-N	
8/6	M12x1	48	10,5	14	16	43	SC27-08-N	
10/8	M14x1	50	8,5	16	17	53	SC27-10-N	
12/10	M16x1	53	8,5	18	19	76	SC27-12-N	
15/12,5	M20x1	58	8,5	22	24	105	SC27-15-N	

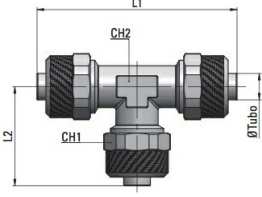

### SC29 T-spojnik, Tlak -1...25bar

	Promjer cijevi D / d [mm]	L1	L2	CH1	CH2	Težina [g]	Tip
	5/3	43	21,5	8	8	17	SC29-05-N
6/4	45	22,5	12	8	32	SC29-06-N	
8/6	45	22,5	14	10	42	SC29-08-N	
10/8	51	25,5	16	11	55	SC29-10-N	
12/10	60	30	18	14	85	SC29-12-N	
15/12,5	68	34	22	17	124	SC29-15-N	

### SC32 Navrtna matica s s pomoću Zaštitna spirala protiv savijanja, Tlak -1...25bar

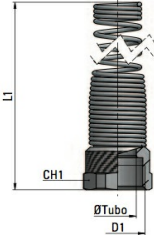
	Promjer cijevi D / d [mm]	D1	L1	CH1	Težina [g]	Tip
	6/4	M10x1	95	12	14	SC32-06-N-YA
8/6	M12x1	93,5	14	18	SC32-08-N-YA	
10/8	M14x1	96,5	16	22	SC32-10-N-YA	
12/10	M16x1	112	15	31	SC32-12-N	

### SC33 Navrtna matica, Tlak -1...25bar

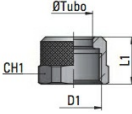
	Promjer cijevi D / d [mm]	D1	L1	CH1	Težina [g]	Tip
	4/2,5	M6x0,75	8	7	1	SC33-04-M6X0,75-N
5/3	M7x0,75	8,5	8	1	SC33-05-M7X0,75-N	
6/4	M8x0,75	9	9	2	SC33-06-M8X0,75-N	
6/4	M10x1	10,5	12	4	SC33-06-M10X1-N	
8/6	M12x1	10,5	14	5	SC33-08-M12X1-N	
10/8	M14x1	11,5	16	7	SC33-10-M14X1-N	
12/10	M16x1	13	18	12	SC33-12-M16X1-N	
15/12,5	M20x1	15,5	22	16	SC33-15-M20X1-N	

### SC35 L-prstenasti spojni komad, Tlak -1...18bar

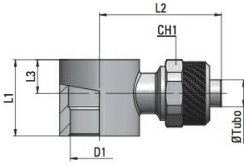
	Promjer cijevi D / d [mm]	D1	L1	L2	L3	CH1	Težina [g]	Tip
	4/2,5	M5	9	19	4,5	7	7	SC35-04-M5-N
4/2,5	M5	10	19	3,5	7	6	SC35-04-M5-N-M*	
4/2,5	G1/8"	15	21,5	6	7	13	SC35-04-18-N	
5/3	M5	9	19	4,5	8	7,5	SC35-05-M5-N	
5/3	M5	10	19	4	8	6,5	SC35-05-M5-N-M*	
5/3	1/8"	15	25	6	12	20	SC35-05-18-N	
6/4	M5	9	19	4	9	9	SC35-06-M5-N	
6/4	M5	10	19	4,5	9	7	SC35-06-M5-N-M*	
6/4	1/8"	15	25	6	12	19	SC35-06-18-N	
6/4	1/4"	17	26,5	7,5	12	25	SC35-06-14-N	
8/6	1/8"	15	25	6	14	19	SC35-08-18-N	
8/6	1/4"	17	27,5	7,5	14	27	SC35-08-14-N	
8/6	3/8"	20	29,5	7,5	14	39	SC35-08-38-N	
10/8	1/4"	17	28,5	7,5	16	30	SC35-10-14-N	
10/8	3/8"	20	30,5	7,5	16	41	SC35-10-38-N	

\*za Zakretni prigušni ventil i Zakretni prigušno-nepovratni ventil

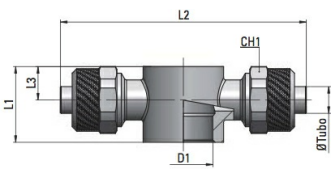

### SC36 T-prstenasti spojni komad, Tlak -1...18bar

	Promjer cijevi D / d [mm]	D1	L1	L2	L3	CH1	Težina [g]	Tip
	5/3	M5	9	34	4,5	8	12	SC36-05-M5-N
5/3	1/8"	15	50	6	12	32	SC36-05-18-N	
6/4	M5	9	34	4,5	9	13	SC36-06-M5-N	
6/4	1/8"	15	50	6	12	30	SC36-06-18-N	
6/4	1/4"	17	53	7,5	12	36	SC36-06-14-N	
8/6	1/8"	15	50	6	14	30	SC36-08-18-N	
8/6	1/4"	17	55	7,5	14	39	SC36-08-14-N	
8/6	3/8"	20	59	7,5	14	52	SC36-08-38-N	
10/8	1/4"	17	57	7,5	16	45	SC36-10-14-N	
10/8	3/8"	20	61	7,5	16	56	SC36-10-38-N	

### SC40 Zatvorna kapica

	Promjer cijevi D / d [mm]	Visina	max. Tlak 20°C	max. Tlak 30°C	max. Tlak 60°C	max. Tlak 80°C	Tip
	5/3	11	16	16	16	16	12
6/4	23	13	10	6	3	SC40-06-D	
8/6	23	8	6	3	2	SC40-08-D	

Slike nisu obvezujuće

Zadržavamo pravo na konstrukcijske, dimenzijske i promjene materijala.

Pneumatika / Spojni elementi i spojnice / Vijčani priključci / Vijčani priključci - Mjed niklan Tlak -1...18bar/25bar

