

Kompakt magnetcyylinder med tillbehör Serie NSK



Konstruktionstyp	Kompaktmagnetcyylinder valfritt enligt UNITOP-standard respektive ISO 21287
Huvuden	Högtrycksgjutning Aluminiumlegering
Kolvstång	Ø16 ÷ 25 Rostfritt stål 1.4401, Ø32 ÷ 100 Rostfritt stål 1.4021
Cylinderrör	Aluminiumprofil hårdanodiserad
Tätningar	Polyuretan
Anslag	mekanisk
Omgivningstemperatur	-20°C...+80°C (-25°C...+120°C för utförande Högtemperaturpolyuretan komplett)
Medietemperatur	0°C...+30°C
Smörjning	inte nödvändigt
Medium	filtrerad tryckluft
maximalt driftryck	10bar
Obs!	CAD-filer finns tillgängliga i STASTO Store på www.stasto.eu Magnetbrytare se separat datablad

Typkod

NSK	U	I	Slaglängd [mm]	F	M	—	—
	UNITOP	16	Ø16	Invändig gänga			dubbelverkande
	ISO 21287	20	Ø20	utvändig gänga			SEA enkelverkande Fjäder framåt
		25	Ø25				SEP enkelverkande Fjäder bakåt
		32	Ø32				P genomgående kolvstång
		40	Ø40				AR vridsäkrad
		50	Ø50				VS Högtemperaturpolyuretan Kolv tätning för kolvstång
		63	Ø63				VV Högtemperaturpolyuretan komplett
		80	Ø80				
		100	Ø100				



NSK . - .. dubbelverkande

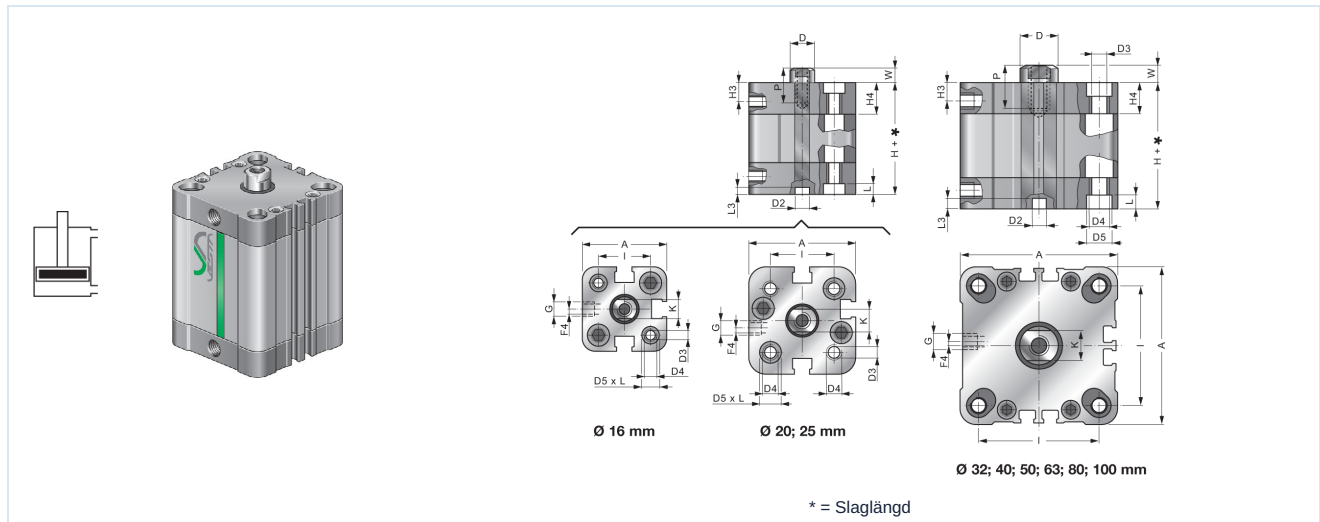

Ø	A	ØD	ØD2	ØD3	ØD4 UNITOP/ISO	ØD5 UNITOP/ISO	G	H3	H4	I UNITOP/ISO	K	L	L3	W UNITOP/ISO	F4	H UNITOP/ISO
16	29,2	8	6	3,3	M4	6	M5	7	12,8	18	6	3,5	2,2	4,5	0	38/37 (± 0,5)
20	37	10	6	4,2	M5	7,5	M5	7	12,3	22	8	4,2	2,5	4,5/6	4	38/37 (± 0,5)
25	41	10	6	4,2	M5	7,5	M5	7,5	13,5	26	8	4,2	2,5	5,5/6	3	39,5/39 (± 0,5)
32	49,2	12	6	5,2	M6	9	G1/8	7,5	15	32/32,5	10	4,5	2	6/7	0	44,5/44 (± 0,5)
40	57,2	12	6	5,2	M6	9	G1/8	7,5	15	42/38	10	4,2	2	6,5/7	0	45,5/45 (± 0,7)
50	67	16	8	6,7	M8	10,5	G1/8	7,5	14,6	50/46,5	13	4,7	2,5	7,58	0	45,5/45 (± 0,7)
63	80	16	8	6,7	M10/M8	13,5/10,5	G1/8	8	15,5	62/56,5	13	5,2	2,5	7,58	0	50/49 (± 0,8)
80	102,6	20	8	8,5	M10	13,5	G1/8	9	17	82/72	17	5,2	2,5	8/10	0	56/54 (± 0,8)
100	124	25	8	8,5	M10	13,5	G1/4	10	20	103/89	22	5,2	3	10	0	66,5/67 (± 1)

NSK . - .. P genomgående kolvstång

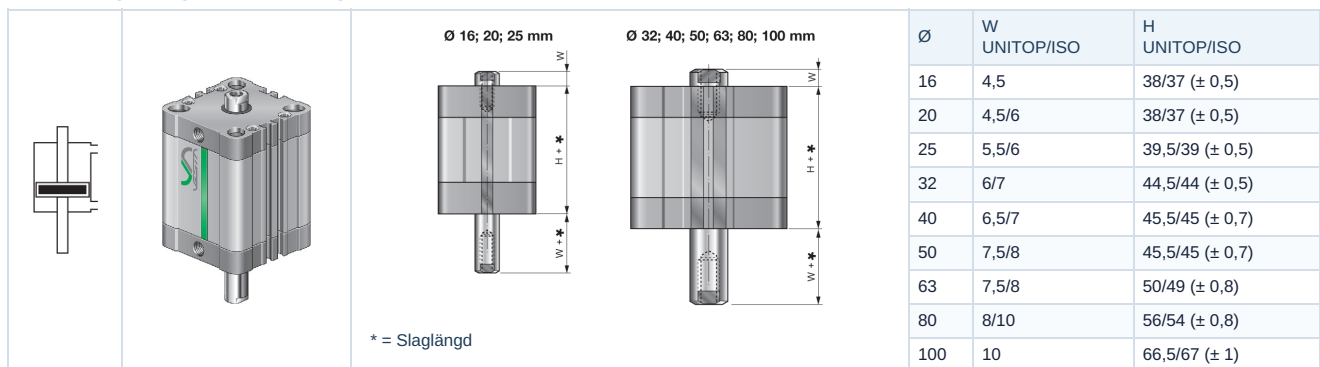

Ø	W UNITOP/ISO	H UNITOP/ISO
16	4,5	38/37 (± 0,5)
20	4,5/6	38/37 (± 0,5)
25	5,5/6	39,5/39 (± 0,5)
32	6/7	44,5/44 (± 0,5)
40	6,5/7	45,5/45 (± 0,7)
50	7,5/8	45,5/45 (± 0,7)
63	7,5/8	50/49 (± 0,8)
80	8/10	56/54 (± 0,8)
100	10	66,5/67 (± 1)

NSK . - F Kolvstång med invändig gänga



Ø	ØD1 UNITOP/ISO	P UNITOP/ISO
16	M4	8
20	M5/M6	10
25	M5/M6	10
32	M6/M8	12
40	M6/M8	12
50	M8/M10	12/16
63	M8/M10	14/16
80	M10/M12	15/20
100	M12	20

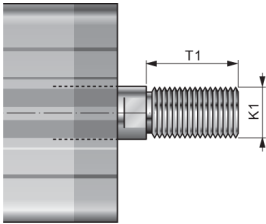

NSK . - ... M Kolvsstång med utvändig gänga

	Ø	ØK1 UNITOP/ISO	T1 UNITOP/ISO
	16	M8x1,25/M6x1	20/12
	20	M10x1,25/M8x1,25	22/16
	25	M10x1,25/M8x1,25	22/16
	32	M10x1,25	22/19
	40	M10x1,25	22/19
	50	M12x1,25	24/22
	63	M12x1,25	24/22
	80	M16x1,5	32/28
	100	M20x1,5/M16x1,5	40/28

NSK . - .. SEA enkelverkande Fjäder framåt

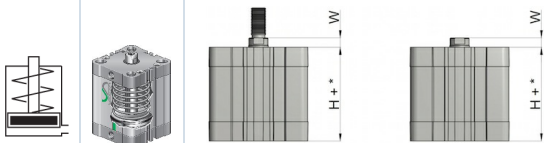
 <p>* = Slaglängd</p>	Ø	Fjäderkraft [N]		H (Slaglängd 0-25mm) UNITOP/ISO	H (Slaglängd 26-50mm) UNITOP/ISO	W UNITOP/ISO
		max.	min.			
	16	21	12	38/37 (± 0,5)	48/47 (± 0,5)	4,5
	20	39	22	38/37 (± 0,5)	48/47 (± 0,5)	4,5/6
	25	45	28	39,5/39 (± 0,5)	59,5/59 (± 0,5)	5,5/6
	32	45	28	44,5/44 (± 0,5)	64,5/64 (± 0,5)	6/7
	40	61	39	45,5/45 (± 0,7)	65,5/65 (± 0,7)	6,5/7
	50	90	58	45,5/45 (± 0,7)	65,5/65 (± 0,7)	7,5/8
	63	95	62	50/49 (± 0,8)	70/69 (± 0,8)	7,5/8
	80	150	115	56/54 (± 0,8)	86/84 (± 0,8)	8/10
	100	160	125	66,5/67 (± 1)	96,5/97 (± 1)	10

NSK . - .. SEP enkelverkande Fjäder bakåt

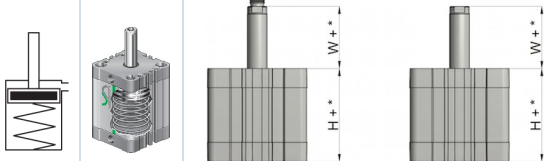
 <p>* = Slaglängd</p>	Ø	Fjäderkraft [N]		H (Slaglängd 0-25mm) UNITOP/ISO	H (Slaglängd 26-50mm) UNITOP/ISO	W UNITOP/ISO
		max.	min.			
	16	21	12	38/37 (± 0,5)	48/47 (± 0,5)	4,5
	20	39	22	38/37 (± 0,5)	48/47 (± 0,5)	4,5/6
	25	45	28	39,5/39 (± 0,5)	59,5/59 (± 0,5)	5,5/6
	32	45	28	44,5/44 (± 0,5)	64,5/64 (± 0,5)	6/7
	40	61	39	45,5/45 (± 0,7)	65,5/65 (± 0,7)	6,5/7
	50	90	58	45,5/45 (± 0,7)	65,5/65 (± 0,7)	7,5/8
	63	95	62	50/49 (± 0,8)	70/69 (± 0,8)	7,5/8
	80	150	115	56/54 (± 0,8)	86/84 (± 0,8)	8/10
	100	160	125	66,5/67 (± 1)	96,5/97 (± 1)	10



NSK ... AR dubbelverkande vridsäkrad

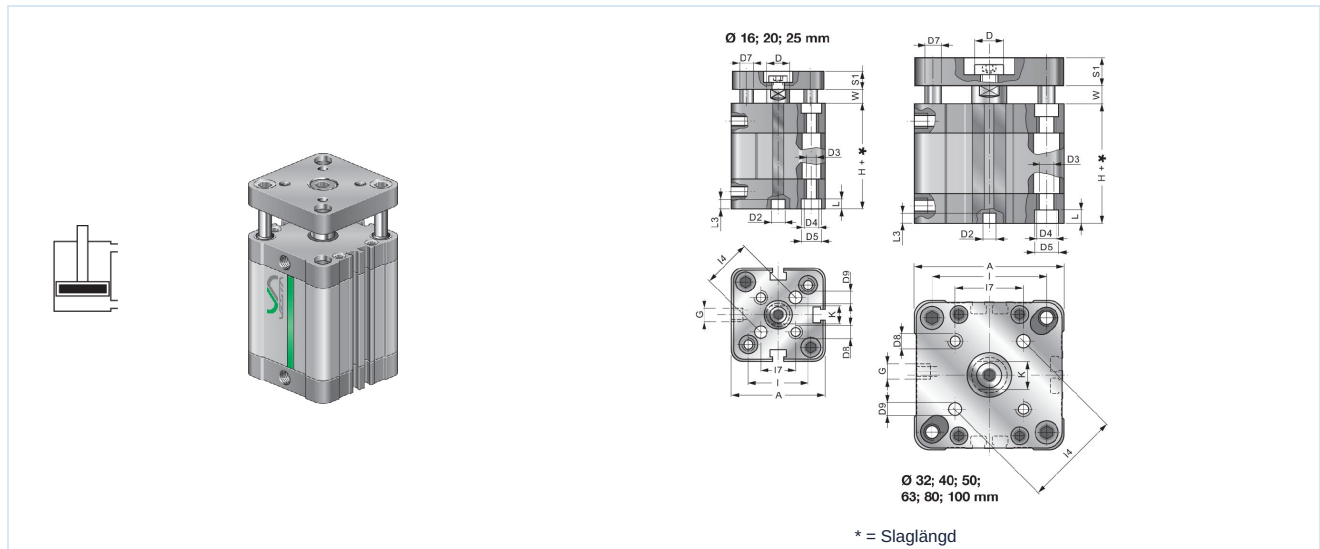

Ø	A	ØD	ØD2	ØD3 UNITOP/ISO	ØD4 UNITOP/ISO	ØD5 UNITOP/ISO	ØD7	ØD8	ØD9	G	I UNITOP/ISO	I4	I7	K	L	L3	S1	W UNITOP/ISO	H UNITOP/ISO
16	29,2	8	6	3,3	M4	6	5	M3	3	M5	18	14	9,9	6	3,5	2,2	6	4,5	38/37 (± 0,5)
20	37	10	6	4,2	M5	7,5	5	M4	4	M5	22	17	12	8	4,2	2,5	8	4,5/6	38/37 (± 0,5)
25	41	10	6	4,2	M5	7,5	6	M5	5	M5	26	22	15,6	8	4,2	2,5	8	5,5/6	39,5/39 (± 0,5)
32	49,2	12	6	5,2	M6	9	8	M5	5	G1/8	32/32,5	28	19,8	10	4,5	2	10	6/7	44,5/44 (± 0,5)
40	57,2	12	6	5,2	M6	9	10	M5	5	G1/8	42/38	33	23,3	10	4,2	2	10	6,5/7	45,5/45 (± 0,7)
50	67	16	8	6,7	M8	10,5	10	M6	6	G1/8	50/46,5	42	29,7	13	4,7	2,5	12	7,58	45,5/45 (± 0,7)
63	80	16	8	8,5/6,7	M10/M8	13,5/10,5	10	M6	6	G1/8	62/56,5	50	35,4	13	5,2	2,5	12	7,58	50/49 (± 0,8)
80	102,6	20	8	8,5	M10	13,5	14	M8	8	G1/8	82/72	65	46	17	5,2	2,5	14	8/10	56/54 (± 0,8)
100	124	25	8	8,5	M10	13,5	14	M10	10	G1/4	103/89	80	56,6	22	5,2	3	14	10	66,5/67 (± 1)

NSK ... TN2 ... Tandem

NSK	_	__ /	___	TN2 P	M
	U	UNITOP	Ø	Slaglängd [mm]	F Invändig gänga
	I	ISO 21287			M utvändig gänga

Ø	A	B
32	88,4	44,2
40	90,4	45,2
50	90,4	45,2
63	99	49,5
80	110	55
100	133,4	66,7

NSK ... BS ... Flerlägesläge

NSK	_	__ /	___	BS	M	
	U	UNITOP	Ø	Slaglängd1 [mm]	Slaglängd2 [mm]	F Invändig gänga
	I	ISO 21287				M utvändig gänga

Ø	A	B
32	88,4	44,2
40	90,4	45,2
50	90,4	45,2
63	99	49,5
80	110	55
100	133,4	66,7



NSK ... CNP ... Flerläges bottenanslutning



NSK	_	__ /	___ -	___ CNP	M
	U UNITOP	∅	Slaglängd1 [mm]	Slaglängd2 [mm]	F Invändig gänga
	I ISO 21287				M utvändig gänga

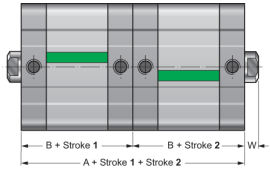

Stroke = Slaglängd

∅	A	B
16	76	38
20	76	38
25	79	39,5
32	88,4	44,2
40	90,4	45,2
50	90,4	45,2
63	99	49,5
80	110	55
100	133,4	66,7

NSK ... CNF ... Flerläges kolvstångssida

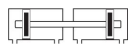

NSK	_	__ /	___ -	___ CNF
	U UNITOP	∅	Slaglängd1 [mm]	Slaglängd2 [mm]
	I ISO 21287			

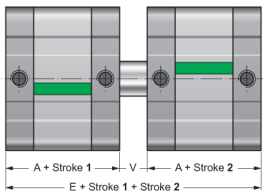

Stroke = Slaglängd

∅	E	A	V
16	85	38	9
20	85	38	9
25	90	39,5	11
32	100,4	44,2	12
40	103,4	45,2	13
50	104,4	45,2	15
63	114	49,5	15
80	126	55	16
100	153,4	66,7	20

Tillbehör

SKCM / .. Flikfäste UNITOP

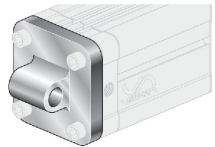

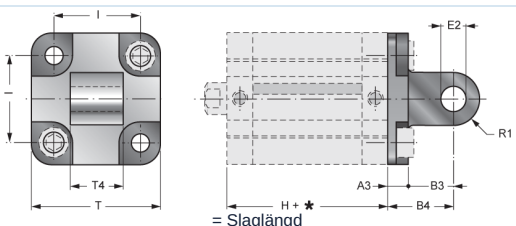

* = Slaglängd

∅	A3	B3	B4	E2	H	I	R1	T	T4	Typ
16	6	10	16	6	38	18	6	27	12	SKCM/16
20	6	14	20	8	38	22	8	34	16	SKCM/20
25	6	14	20	8	39,5	26	8	638	16	SKCM/25

XCM / .. Flikfäste ISO 15552



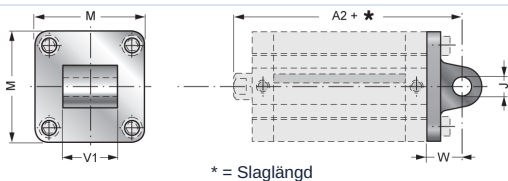

* = Slaglängd

∅	A2	∅J	M	V1	W	Typ
32	73	10	47	26	22	XCM/32
40	77	12	54	28	25	XCM/40
50	80	12	66	32	27	XCM/50
63	89	16	78	40	32	XCM/63
80	100	16	98	50	36	XCM/80
100	118	20	115	60	41	XCM/100



SKCF / .. Gaffelfäste UNITOP

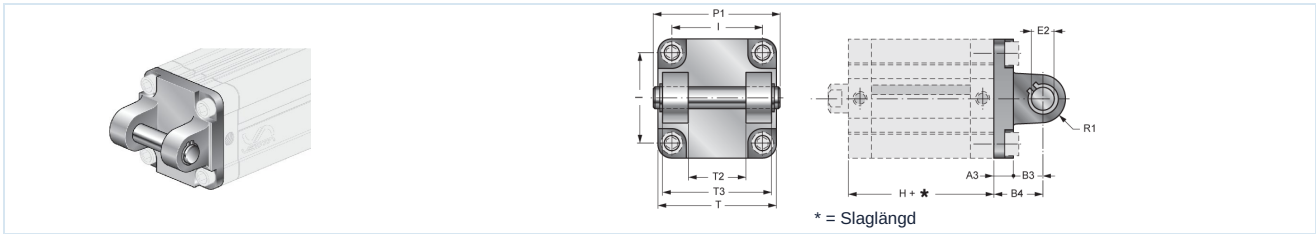

Ø	A3	B3	B4	E2	H	I	P1	R1	T	T2	T3	Typ
32	9	13	22	10	44,5	32	53	10	48	26	45	SKCF/32
40	9	16	25	12	45,5	42	60	12,5	58	28	52	SKCF/40
50	11	16	27	12	45,5	50	68	12,5	66	32	60	SKCF/50
63	11	21	32	16	50	62	78	15	83	40	70	SKCF/63
80	13	23	36	16	56	82	98	15	102	50	90	SKCF/80
100	15	26	41	20	66,5	103	118	20	123	60	110	SKCF/100

XCF / .. Gaffelfäste fram och bak ISO 15552

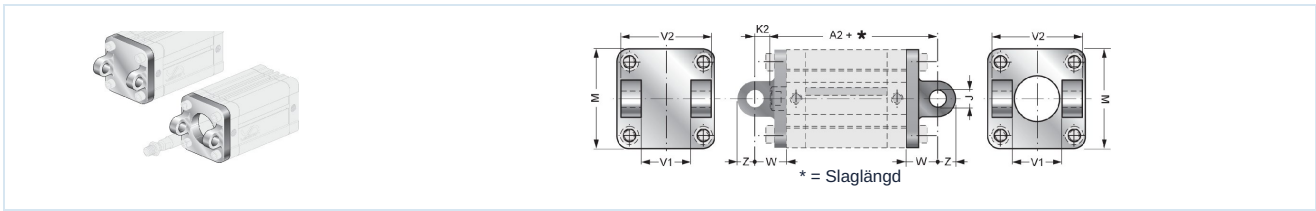

Ø	A2	ØJ	K2	M	V1	V2	W	Z	Typ framåt	Typ bakre
32	73	10	15	45	26	45	22	11	XCFA/32	XCF/32
40	77	12	18	52	28	52	25	13	XCFA/40	XCF/40
50	80	12	19	65	32	60	27	13	XCFA/50	XCF/50
63	89	16	24	75	40	70	32	17	XCFA/63	XCF/63
80	100	16	26	95	50	90	36	17	XCFA/80	XCF/80
100	118	20	31	115	60	110	41	21	XCFA/100	XCF/100

SKFL / .. Flänsmontering UNITOP

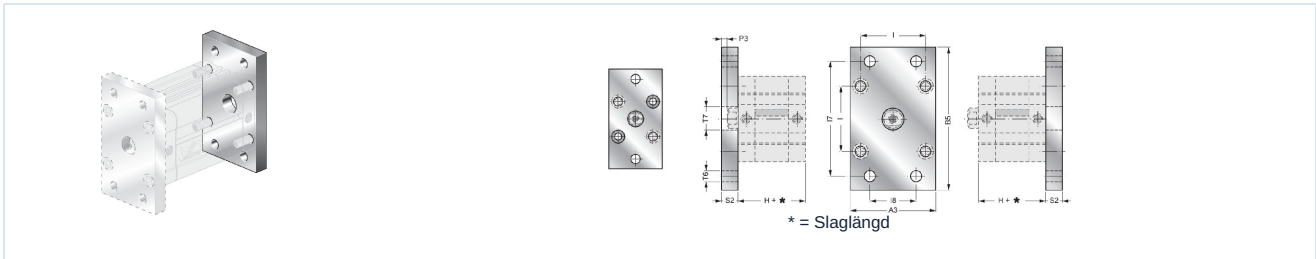

Ø	A3	B5	H	I	I7	I8	P3	S2	T6	T7	Typ
16	29	55	38	18	43	-	5,5	10	5,5	10	SKFL/16
20	36	70	38	22	55	-	5,5	10	6,5	12	SKFL/20
25	40	76	39,5	26	60	-	4,5	10	6,5	12	SKFL/25
32	50	80	44,5	32	65	32	4	10	7	14	SKFL/32
40	60	102	45,5	42	82	36	3,5	10	9	14	SKFL/40
50	68	110	45,5	50	90	45	4,5	12	9	18	SKFL/50
63	87	130	50	62	110	50	7,5	15	9	18	SKFL/63
80	107	160	56	82	135	63	7	15	12	23	SKFL/80
100	128	190	66,5	103	163	75	5	15	14	28	SKFL/100



XFL / .. Flänsmontering ISO 15552

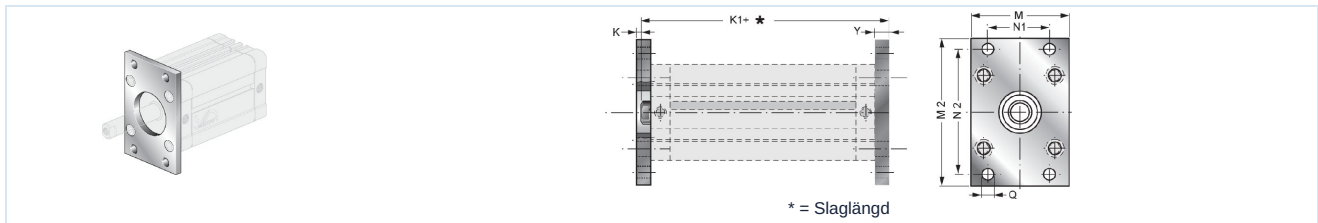

Ø	K	K1	M	M2	N1	N2	ØQ	Y	Typ
32	3	61	45	80	32	64	7	10	XFL/32
40	3	62	52	90	36	72	9	10	XFL/40
50	4	65	65	110	45	90	9	12	XFL/50
63	4	69	75	120	50	100	9	12	XFL/63
80	6	80	95	150	63	126	12	16	XFL/80
100	6	93	115	170	75	150	14	16	XFL/100

SKP / .. Fotfäste UNITOP

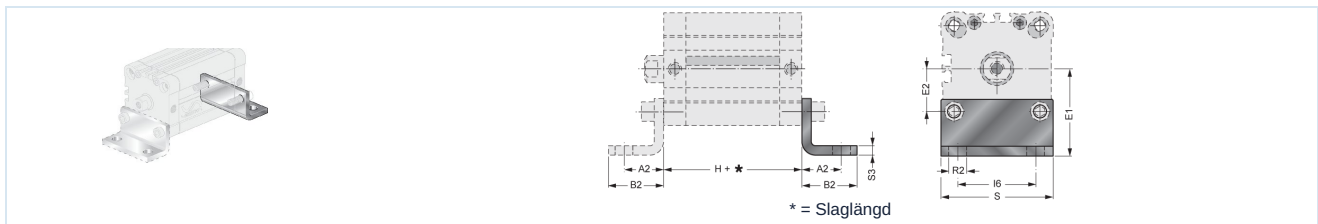

Ø	A2	B2	E1	E2	H	I6	R2	S	S3	Typ
16	13	17,5	22	9	38	18	5,5	30	3	SKP/16
20	16	22	27	11	38	22	6,5	36	4	SKP/20
25	16	22	30	13	39,5	26	6,5	40	4	SKP/25
32	18	26	32	16	44,5	32	6,5	50	5	SKP/32
40	20	28	42,5	21	45,5	42	9	60	5	SKP/40
50	24	32	47	25	45,5	50	9	68	6	SKP/50
63	27	39	59,5	31	50	62	11	84	6	SKP/63
80	30	42	65,5	41	56	82	11	102	8	SKP/80
100	33	45	78	51,5	66,5	103	13,5	123	8	SKP/100

XP / .. Fotfäste ISO 15552

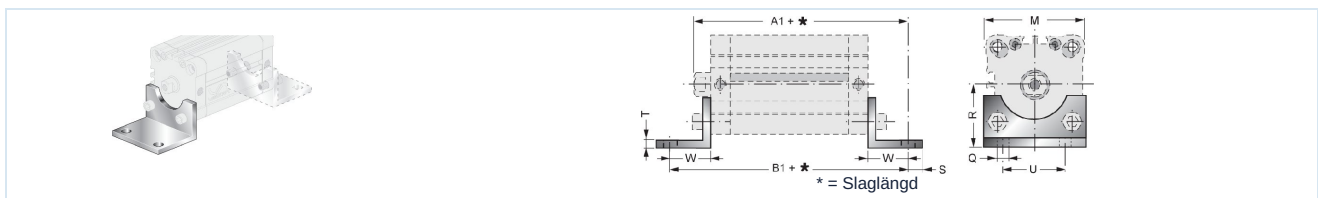

Ø	A1	B1	M	ØQ	R	S	T	U	W	Typ
32	75	92	45	7	32	11	4	32	24	XP/32
40	80	101	52	9	36	15	4	36	28	XP/40
50	85	109	65	9	45	15	5	45	32	XP/50
63	89	113	75	9	50	15	5	50	32	XP/63
80	105	136	95	12	63	20	6	63	41	XP/80
100	118	149	115	14	71	25	6	75	41	XP/100



XCBF/ .. Svängfäste ISO 15552

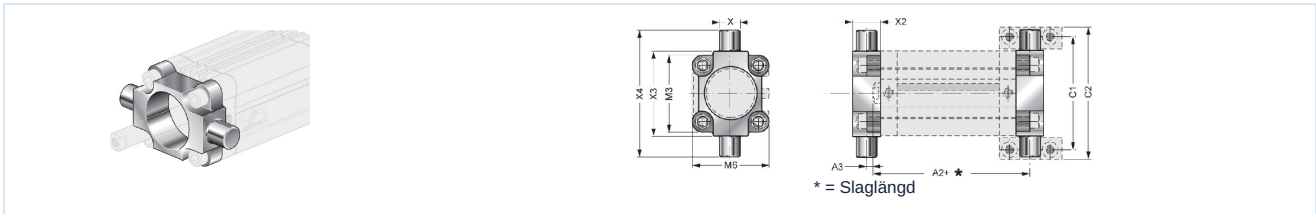

Ø	A2	A3	C1	C2	M3	M6	X e9	X2	X3	X4	Typ
32	58,5	0,5	71	86	45	45	12	15	50	74	XCBF/32
40	62	3	87	105	54	54	16	20	63	95	XCBF/40
50	63	2	99	117	64	64	16	20	75	107	XCBF/50
63	69,5	4,5	16	136	75	75	20	25	90	130	XCBF/63
80	76,5	2,5	36	156	93	93	20	25	110	150	XCBF/80
100	92	5	64	189	110	110	25	30	132	182	XCBF/100

XAS/ .. Vinkelsvängfäste lätt CETOP RP107P ISO

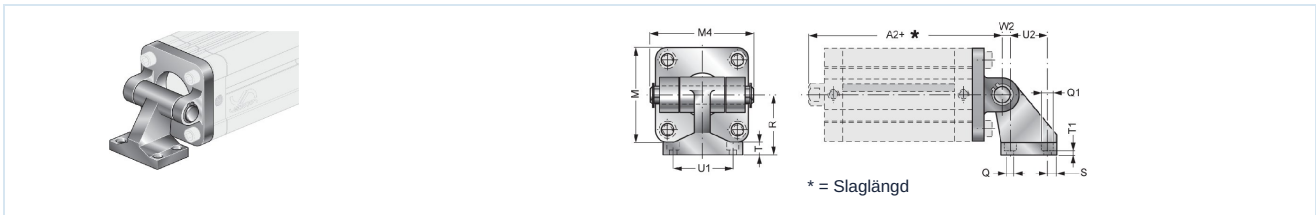

Ø	A2	M	M4	ØQ	ØQ1	R	S	T	T1	U1	U2	W2	Typ
32	73	45	54	7	11	32	6,5	8	6,5	38	18	3	XAS/32
40	77	52	63	7	11	36	6,5	10	8,5	41	22	2	XAS/40
50	80	65	71	9	15	45	7,5	12	10,5	50	30	3	XAS/50
63	89	75	81	9	15	50	7,5	14	12,5	52	35	2	XAS/63
80	100	95	101	11	18	63	10	14	11,5	66	40	7	XAS/80
100	118	115	123	11	18	71	10	17	14,5	76	50	5	XAS/100

XASV/ .. Vinkelsvängfäste tungt ISO

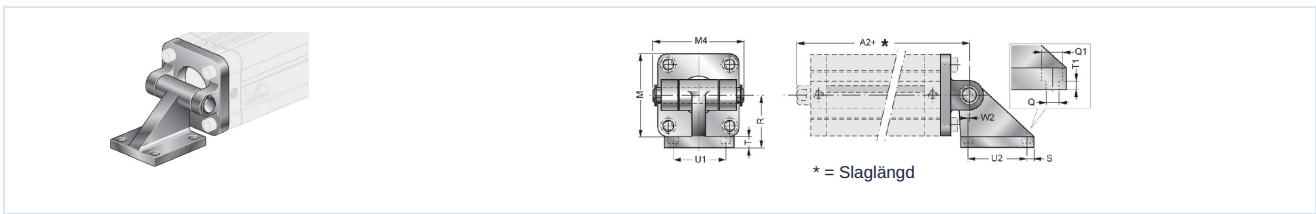

Ø	A2	M	M4	ØQ	ØQ1	R	S	T	T1	U1	U2	W2	Typ
32	73	45	54	7	11	32	8	10	5	32,5	32,5	0	XASV/32
40	77	52	63	7	11	36	8,5	10	5	38	38	0	XASV/40
50	80	65	71	9	15	45	10	12	5	46,5	46,5	0	XASV/50
63	89	75	81	9	15	50	10	12	5	56,5	56,5	0	XASV/63
80	100	95	101	11	18	63	12,5	14	6	72	72	0	XASV/80
100	118	115	123	11	18	73	13	16	6	89	89	0	XASV/100



XANL/ .. Svängfäste ISO

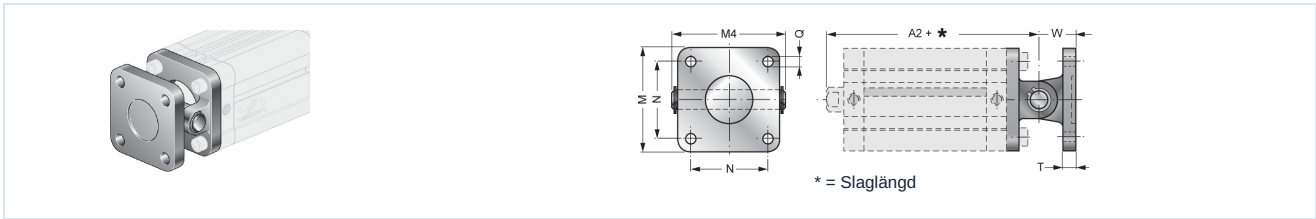

Ø	A2	M	M4	N	ØQ	T	W	Typ
32	73	45	54	32,5	7	10	22	XANL/32
40	77	52	63	38	7	10	25	XANL/40
50	80	65	71	46,5	9	12	27	XANL/50
63	89	75	81	56,5	9	12	32	XANL/63
80	100	95	101	72	11	16	36	XANL/80
100	118	115	123	89	11	16	41	XANL/100

XANN/ .. Svängfäste ISO

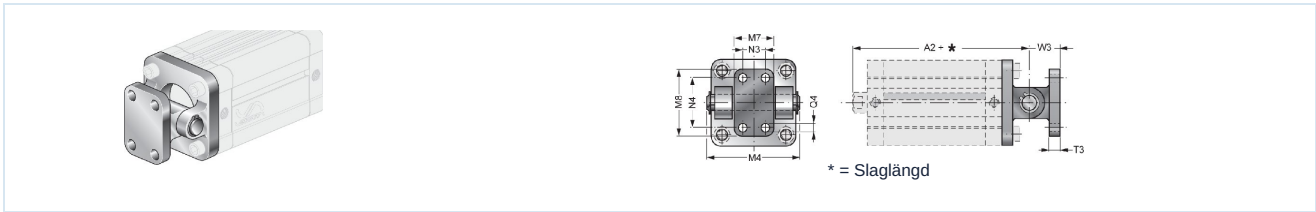

Ø	A2	M4	M7	M8	N3	N4	ØQ4	T3	W3	Typ
32	73	54	25	40	-	28	7	8	18	XANN/32
40	77	63	28	52	16	38	9	10	26	XANN/40
50	80	71	32	52	16	38	9	10	26	XANN/50
63	89	81	40	75	25	54	11	12	34	XANN/63
80	100	101	50	75	25	54	11	12	34	XANN/80
100	118	123	60	115	32	90	14	16	41	XANN/100

XAS-SN/ .. Vinkelsvängfäste sfärisk ISO

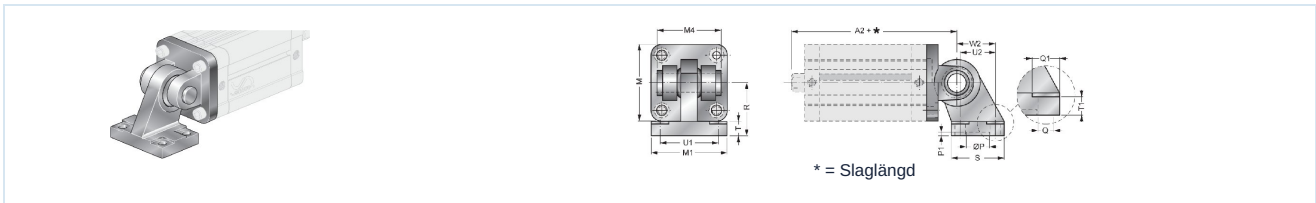

Ø	A2	M	M1	41	ØP	P1	ØQ	ØQ1	R	S	T	T1	U1	U2	W2	Typ
32	73	45	51	41	20	3	6,6	11	32	31	10	8,5	38	18	21	XAS-SN/32
40	77	52	54	48	20	3	6,6	11	26	35	10	8,5	41	22	24	XAS-SN/40
50	80	65	65	54	20	3	9	15	45	45	12	10,5	50	30	33	XAS-SN/50
63	89	75	67	69	20	3	9	15	50	50	12	10,5	52	35	37	XAS-SN/63
80	100	95	86	75	20	3	11	18	63	60	14	11,5	66	40	47	XAS-SN/80
100	118	115	96	85	20	3	11	18	71	70	15	12,5	76	50	55	XAS-SN/100



XCM-SN-AC/ .. Flik med sfärisk lagring, Stål ISO

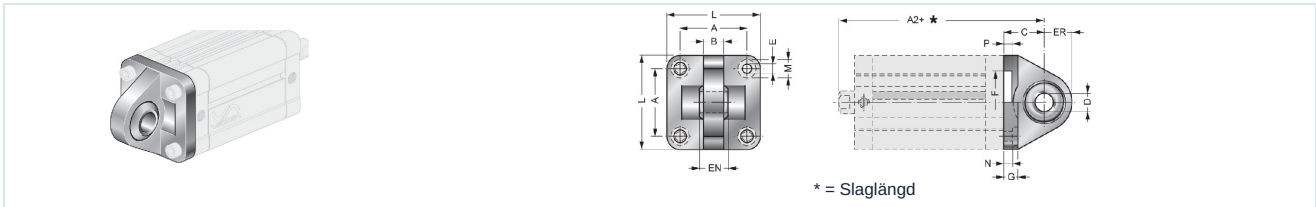

Ø	A2	A	B	C	D	EN	ER	F	G	E	L	M	N	P	Typ
32	73	32,5	10,5	22	10	14	15	30	10	6,6	45	10,5	5,5	5	XCM-SN-AC/32
40	77	38	12	25	12	16	18	35	10	6,6	55	11	5,5	5	XCM-SN-AC/40
50	80	46,5	15	27	16	21	20	40	10	9	65	15	6,5	5	XCM-SN-AC/50
63	89	56,5	15	32	16	21	23	45	12	9	75	15	6,5	5	XCM-SN-AC/63
80	100	72	18	36	20	25	27	45	14	11	95	18	10	5	XCM-SN-AC/80
100	118	89	18	41	20	25	30	55	16	11	115	18	10	5	XCM-SN-AC/100

XCM-SN-AL/ .. Flik med sfärisk lagring, Aluminium ISO

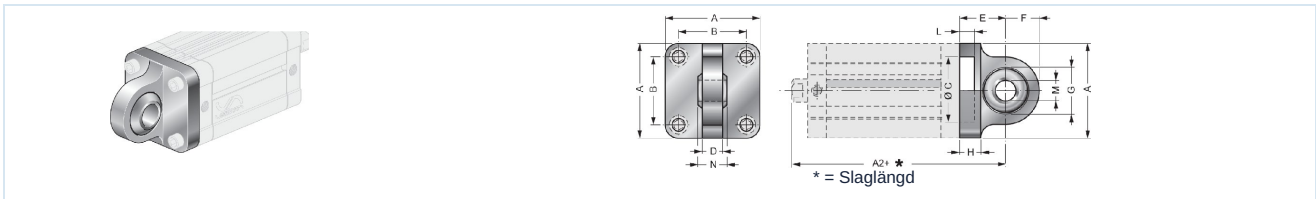

Ø	A2	A	B	C	D	E	F	G	H	L	ØM	N	Typ
32	73	45	32,5	30	10	22	16	22	10	7	10	14	XCM-SN-AL/32
40	77	52	38	35	12	25	19	26	10	7	12	16	XCM-SN-AL/40
50	80	65	46,5	40	12	27	19	26	12	7	16	21	XCM-SN-AL/50
63	89	75	56,5	45	15	32	24	32	12	7	16	21	XCM-SN-AL/63
80	100	95	72	45	15	36	24	32	16	9	20	25	XCM-SN-AL/80
100	118	115	89	55	18	41	30	40	16	9	20	25	XCM-SN-AL/100

USC/ .. Tvärbult

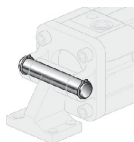
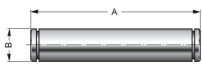
	Ø	A	B f7	Typ
				
				
	32	54	10	USC/32
	40	63	12	USC/40
	50	71	12	USC/50
	63	81	16	USC/63
	80	101	16	USC/80
	100	123	20	USC/100

Bilderna är inte bindande
Rätt till konstruktions-, mått- och materialändringar förbehålles

